

**FINAL INVESTIGATION REPORT ON SERIOUS INCIDENT**  
**TO M/s CATHAY PACIFIC LTD. BOEING B747-400**  
**AIRCRAFT REGISTRATION B-HUL AT IGI AIRPORT**  
**DELHI ON 27.07.2015**

**COMMITTEE OF INQUIRY B-HUL**

(K Ramachandran)  
AAIB  
Member

(Raje Bhatnagar)  
AAIB  
Chairman

## **Foreword**

*In accordance with Annex 13 to the Convention on International Civil Aviation Organization (ICAO) and Rule 03 of Aircraft (Investigation of Accidents and Incidents), Rules 2012, the sole objective of the investigation of an accident/incident shall be the prevention of accidents/incidents and not apportion blame or liability.*

*This document has been prepared based upon the evidences collected during the investigation, opinion obtained from the experts and laboratory examination of various components. Consequently, the use of this report for any purpose other than for the prevention of future accidents/incidents could lead to erroneous interpretations.*

| <b><u>INDEX</u></b>    |   |                        |
|------------------------|---|------------------------|
| <b><u>CONTENTS</u></b> |   | <b><u>PAGE No.</u></b> |
|                        | SYNOPSIS                                | 02                     |
| <b>1</b>               | <b>FACTUAL INFORMATION</b>              | 03                     |
| 1.1                    | HISTORY OF THE FLIGHT                   | 03                     |
| 1.2                    | INJURIES TO PERSONS                     | 04                     |
| 1.3                    | DAMAGE TO AIRCRAFT                      | 04                     |
| 1.4                    | OTHER DAMAGE                            | 12                     |
| 1.5                    | PERSONNEL INFORMATION                   | 12                     |
| 1.6                    | AIRCRAFT INFORMATION                    | 14                     |
| 1.7                    | METEOROLOGICAL INFORMATION              | 25                     |
| 1.8                    | AIDS TO NAVIGATION                      | 26                     |
| 1.9                    | COMMUNICATIONS                          | 26                     |
| 1.10                   | AERODROME INFORMATION                   | 26                     |
| 1.11                   | FLIGHT RECORDERS                        | 27                     |
| 1.12                   | WRECKAGE AND IMPACT INFORMATION         | 28                     |
| 1.13                   | MEDICAL AND PATHOLOGICAL INFORMATION    | 33                     |
| 1.14                   | FIRE                                    | 33                     |
| 1.15                   | SURVIVAL ASPECTS                        | 33                     |
| 1.16                   | TESTS AND RESEARCH                      | 33                     |
| 1.17                   | ORGANISATIONAL & MANAGEMENT INFORMATION | 35                     |
| 1.18                   | ADDITIONAL INFORMATION                  | 35                     |
| 1.19                   | USEFUL AND EFFECTIVE TECHNIQUES         | 37                     |
| <b>2</b>               | <b>ANALYSIS</b>                         | 37                     |
| 2.1                    | SERVICEABILITY OF AIRCRAFT              | 37                     |
| 2.2                    | WEATHER                                 | 38                     |
| 2.3                    | PILOT FACTOR                            | 38                     |
| 2.4                    | CIRCUMSTANCES LEADING TO INCIDENT       | 39                     |
| <b>3</b>               | <b>CONCLUSIONS</b>                      | 43                     |
| 3.1                    | FINDINGS                                | 43                     |
| 3.2                    | PROBABLE CAUSE OF THE INCIDENT          | 46                     |
| <b>4</b>               | <b>SAFETY RECOMMENDATIONS</b>           | 47                     |

**FINAL INVESTIGATION REPORT ON SERIOUS INCIDENT TO M/s CATHAY  
PACIFIC AIRWAYS LTD. BOEING B747-400 AIRCRAFT REGISTRATION B-HUL  
AT IGI AIRPORT DELHI ON 27.07.2015**

|     |                               |   |
|-----|-------------------------------|---|
| 1.  | Aircraft Type                 | Boeing B 747-400                                    |
| 2.  | Nationality                   | Hong Kong   |
| 3.  | Registration                  | B-HUL   |
| 4.  | Owner                         | Cathay Pacific Airways Ltd., Hong Kong              |
| 5.  | Operator                      | Cathay Pacific Airways Ltd., Hong Kong.             |
| 6.  | Pilot – in –Command           | ATPL holder (Hong Kong)                             |
|     | Extent of Injuries            | Nil   |
| 7.  | Co-Pilot                      | ATPL Holder (Hong Kong)                             |
|     | Extent of Injuries            | Nil   |
| 8.  | Place of Incident             | Delhi   |
| 9.  | Co-ordinates of incident Site | 28° 34' 01" N, 77° 05' 14" E                        |
| 10. | Last point of Departure       | Hong Kong   |
| 11. | Intended place of Landing     | Delhi   |
| 12. | Date & Time of Incident       | 27 <sup>th</sup> July 2015, 1240 UTC                |
| 13. | Passengers on Board           | Nil   |
| 15. | Crew on Board                 | 02  |
| 16. | Extent of Injuries            | Nil   |
| 17. | Phase of Operation            | Landing Roll  |
| 18. | Type of incident:             | Aircraft part (Flap) disintegration during landing. |

(ALL TIMINGS IN THE REPORT ARE IN UTC)

## **Synopsis**

On 27th July 2015, M/s Cathay Pacific Airways Ltd. Boeing B747-400F aircraft with registration B-HUL was involved in a serious incident while operating cargo flight CX3217 (Hong Kong – New Delhi). The aircraft was under the command of a pilot ATPL Holder (Hong Kong) on type with a co-pilot also an ATPL holder (Hong Kong) on type. There was no injury to any person on board the aircraft.

The aircraft landed in Delhi on runway 10 at 1240 UTC and during the taxi-in, the Ground controller contacted the flight crew and informed them that a part had separated from the aircraft during the landing. The flight crew after reaching the bay, instructed the ground engineer to perform a walk around inspection (WAI) which initially did not reveal any missing parts. The flight crew then fully extended the wing flaps and the engineer reported that the left wing inboard trailing edge fore-flap was missing. The damage was limited to the failed aircraft parts and their associated system. There was no injury to any occupant on board the aircraft. There was no fire.

Ministry of Civil Aviation constituted a Committee of Inquiry to investigate into the causes of the serious incident under Rule 11 of Aircraft (Investigation of Accidents and Incidents) Rules 2012 vide MoCA order no. AV.15018/209/2015 - DG.

## **1.0 FACTUAL INFORMATION**

### **1.1 History of Flight**

On 27th July 2015 M/s Cathay Pacific Airways Ltd. Boeing B747-400F aircraft was scheduled to operate cargo flight CX3217 from Hong Kong to Delhi under the command of pilot and Co-pilot both ATPL holder (Hong Kong) and qualified on type.

The aircraft which was a cargo flight departed from Hong Kong at 0645 UTC for Delhi. The enroute flight was uneventful. The approach and descent to Delhi was also uneventful and there was no signal in the cockpit for any abnormality. The Delhi ATC cleared the aircraft for landing on runway 10. The aircraft landed in Delhi on runway 10 at 1240 UTC. After landing, while the aircraft was taxiing in, the ground controller contacted the flight crew and informed them that a part of the aircraft had separated from the aircraft during landing. The flight crew after parking the aircraft at the designated bay instructed the ground personnel/engineers to perform a walk around inspection (WAI) to verify any part of the aircraft missing. During the initial walk around inspection the ground personnel/engineers did not find any part missing. The flight crew then fully extended the wing flaps and again instructed the engineers to perform the WAI. During the WAI the ground engineer reported that the left wing inboard trailing edge fore-flap was missing. The ATC was then informed about the same. The ATC then instructed M/s Delhi International Airport Limited (DIAL) to carry out runway inspection for the missing part. The same was carried out and the separated inboard trailing edge fore flap was recovered. The fore flap was broken into three pieces after impacting with ground. Further a sweep of runway & taxiways were performed by DIAL personnel to confirm there were no further parts separated from the aircraft. The flight crew stated that they did not realise that the fore flap had separated during landing as they did not observe any abnormalities during the flight. The damage was confined to the separated fore flap and its associated components. There was no injury to any of the occupant on board the aircraft. There was no fire.

## 1.2 Injuries to Persons

| INJURIES   | CREW | PASSENGERS | OTHERS |
|------------|------|------------|--------|
| FATAL      | Nil  | Nil        | Nil    |
| SERIOUS    | Nil  | Nil        | Nil    |
| MINOR/NONE | 02   | Nil        |        |

## 1.3 Damage to the aircraft

The left wing inboard trailing edge fore-flap detached from its mounting. The fore flap fell on the runway and was broken into three pieces.





Following main damages were observed on the aircraft structure.

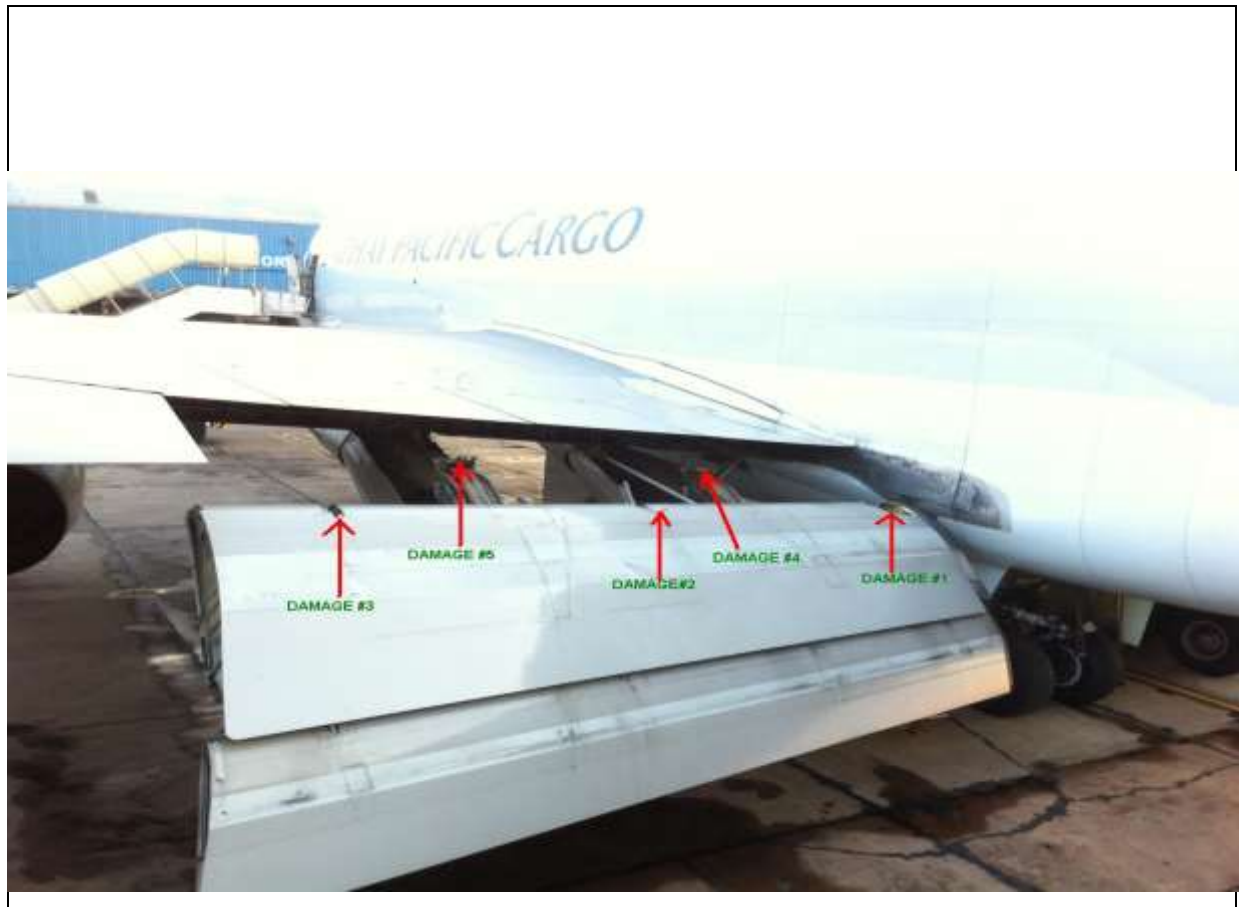



|          |           |   |
|----------|-----------|---|
| Damage 1 | Damage 1A | Bull Nose of about 24 Inches from inboard edge was found missing. |
|----------|-----------|---|



|           |  |
|-----------|--|
| Damage 1B | Inboard Mid Flap to foreflap Cut out was found Ripped Off. |
|-----------|--|



Damage  
1C

2 Dents Measuring 4" X 1.5" X 3/32" and 18" X 1" X 3/64"



Damage  
1D

Crease along the AL Skin 9" X 0.5" X 3/32" with skin puncture at outboard side and Honeycomb Visible.



Damage 2

Damage  
2A

Puncture to Bull Nose Upper Surface with Area 20" and depth 1" Honeycomb Visible.



Damage  
2B

Puncture to skin to Honeycomb L X B = 4" X 3"



|  |  |   |
|--|--|---|
|  | Damage 2C  | Linkage Cut out Bottom Angle Bracket deformed and detached. |
|   |  |   |
| Damage 3   | Linkage (Mid Flap Track) sheared off (Missing) with Damage to attachment Point. Also skin missing (L X B =19"X5"). |   |
|  |  |   |

Damage 4 No. 4 Flap Track Inboard Fore Flap Carriage Assembly Broken.



Damage 5 No. 3 Flap Track Inboard Fore Flap Carriage Assembly Intact With Broken Linkage Eye End Attached.



Damage 6 LH Inboard Aileron Inboard Attachment Frame rubber seal partially missing with few scratches on Flap Stowage Bracket Track.



Damage 7 Detent roller of #4 sequence carriage was found broken and detached from the carriage.



#### 1.4 Other Damage

Nil

#### 1.5 Personnel Information

##### 1.5.1 Pilot-in-Command (Pilot Flying)

|  |                        |
|--|------------------------|
| AGE  | 43 Years               |
| License                                      | ATPL (Hong Kong – CAD) |
| Date of License Issue                        | 12/11/2005             |
| Category                                     | Aeroplane              |
| Class  | Multi Engine, Land     |
| Endorsements as PIC                          | B747-400               |
| Date of Joining Company                      | 12/09/2005             |
| Instrument Rating                            | 04/01/2015             |
| Date of Med. Exam                            | 23/09/2014             |
| Date of Route Check                          | 16/05/2015             |
| Date of Last Proficiency Check               | 04/01/2015             |
| Total flying experience                      | 9772:24 hours          |
| Total Experience on type                     | 4635:30 hours          |
| Total Experience as PIC on type              | 2212:12 hours          |
| Last flown on type                           | 23/07/2015             |
| Total flying experience during last 01 Year  | 491:27 hours           |
| Total flying experience during last 180 days | 223:53 hours           |
| Total flying experience during last 90 days  | 137:48 hours           |
| Total flying experience during last 30 days  | 25:30 hours            |
| Total flying experience during last 07 Days  | 15:44 hours            |
| Total flying experience during last 24 Hours | Nil                    |

### 1.5.2 Co-Pilot (Pilot Monitoring)

|  |                        |
|--|------------------------|
| AGE  | 45 Years               |
| License                                      | ATPL (Hong Kong - CAD) |
| Date of License Issue                        | 28/10/2004             |
| Category                                     | Aeroplane              |
| Class  | Multi Engine, Land     |
| Endorsements as PIC                          | B747-400               |
| Date of Joining Company                      | 23/08/2004             |
| Date of Endorsement as PIC on type           | 10/09/2009             |
| Instrument Rating                            | 23/05/2015             |
| Date of last Medical Exam                    | 11/05/2015             |
| Date of Route Check                          | 11/12/2014             |
| Date of Last Proficiency Check               | 23/05/2015             |
| Total flying experience                      | 9216:25 hours          |
| Total Experience on type                     | 2990:00 hours          |
| Total Experience as PIC                      | 2980:00 hours          |
| Last flown on type                           | 26/07/2015             |
| Total flying experience during last 01 Year  | 594:59 hours           |
| Total flying experience during last 180 days | 281:17 hours           |
| Total flying experience during last 90 days  | 143.44 hours           |
| Total flying experience during last 30 days  | 46.59 hours            |
| Total flying experience during last 07 Days  | 17: 40 hours           |
| Total flying experience during last 24 Hours | Nil                    |



## 1.6 Aircraft Information

### 1.6.1 Aircraft Description

Boeing B747-400 is a subsonic, medium-range, civil transport aircraft. The aircraft is designed for operation with two pilots. The aircraft is certified in Transport (Cargo) category, for day and night operation under VFR & IFR. The maximum take-off weight is 394625 Kgs. The Maximum Landing weight is 302092 Kgs.

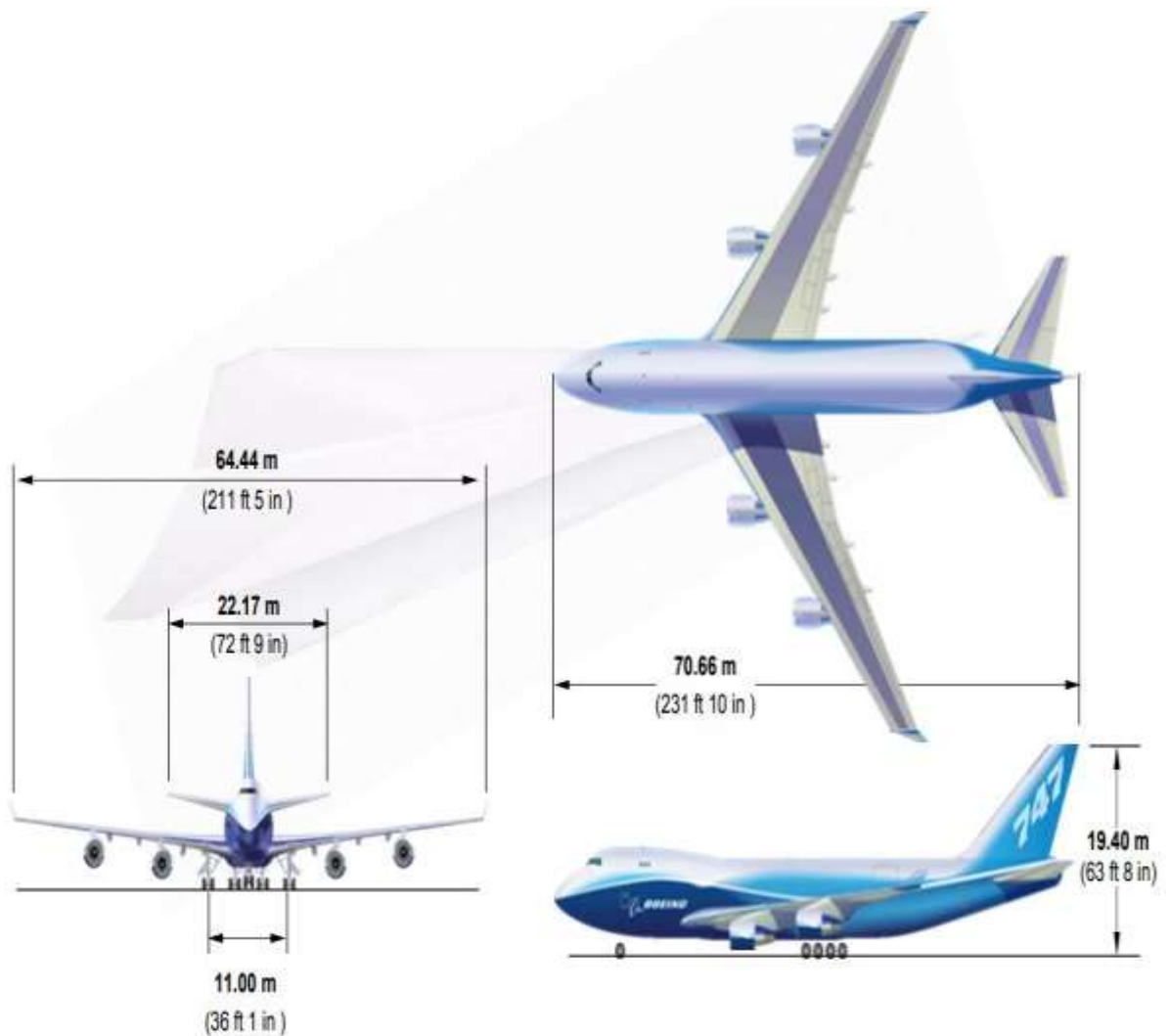

*Three View Diagram of Boeing B747-400*

### 1.6.2 Trailing Edge Flap System - Description and Operation

Two triple-slotted trailing edge (TE) flaps on each wing provide additional lift during take-off, approach & landing and a decreased stalling speed for take-off & landing. As the trailing edge flaps are progressively extended, wing geometry is changed by first extending the chord and then increasing camber. Wing area and camber are further increased by a total number of 28 leading edge (LE) flaps, which operate in conjunction with the trailing edge flaps.

- The inboard and outboard trailing edge (TE) flaps are positioned by independent drive systems. In normal operation, the TE flaps are hydraulically powered. As a backup to hydraulically powered operation, the flaps may be positioned by electric motors.
- The flaps are normally controlled from a flap control lever on the pilots' control stand. The lever is linked to a triple Rotary Variable Differential Transformer (RVDT) assembly. Each RVDT converts flap lever position to an electrical signal which is sent to the flap control units in the main electrical equipment centre. The flap control units monitor flap lever position and other airplane systems to command the flap actuator to change flap position.
- The flap actuator in the left body gear wheel well moves the input cranks to the inboard and outboard flap power packages when commanded by the flap control units. The input cranks position a control valve in each power package to port hydraulic fluid to the hydraulic motors. Each hydraulic motor is joined to a reduction gearbox which drives a torque tube extending into each wing. Angle gearboxes are installed along the torque tubes to permit change of direction. The torque tubes connect to two transmissions at each flap. The transmissions position the mid flap of each three-part TE flap set through ball screw drives. Fore flaps and aft flaps are positioned as the mid flap is moved.
- An electric motor in each power package drives the TE flaps as an alternate to hydraulically powered operation. If flaps fail to move under hydraulic power, the flap control units automatically activate the alternate electric motors to position

the flaps. The motors can also be controlled independently of the flap control units with switches on the pilots centre instrument panel.

- RVDT flap position transmitters are installed in 7 places throughout the TE flap drive mechanisms. An RVDT transmitter is installed in each power package and in the outboard transmission of each flap. The flap actuator has an integral RVDT transmitter. Each RVDT transmitter is wired to all 3 flap control units, which process the position signal for use in flap control, position indication, and asymmetry and failure detection.

Each flap assembly is a triple-slotted flap which consists of a fore flap, mid flap, and aft flap. The three flap segments are mechanically separated to form three slots as the flaps are extended. Each mid flap is attached to and is supported by two flap carriages which travel on the flap tracks. The mid flap is attached to two ball screw and ball nut assemblies which are each driven by a transmission to extend or retract the flap.

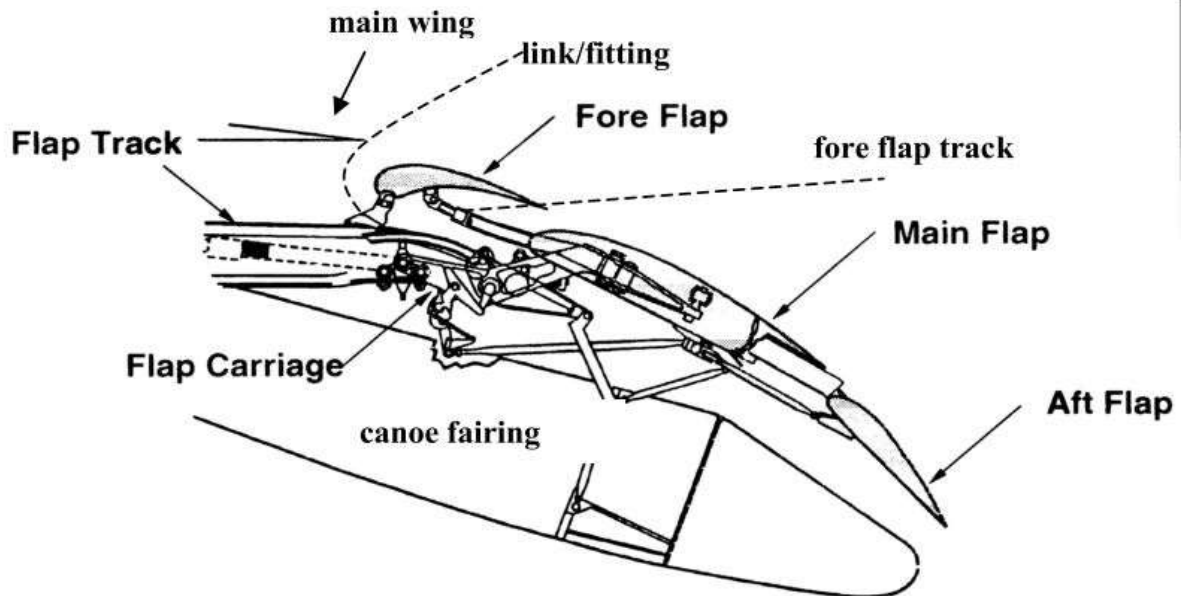

### Fore flaps

The fore flaps consist of front and rear spars connected by skin panels, a curved nose skin section, and a trailing edge. The fore flaps are supported by a track which extends into the mid flap where it contacts rollers. The position of the fore flap is established by sequencing carriages attached to this surface. The fore flap

extends with the mid flap until the sequencing carriages contact detents in the flap tracks. At this point, the fore flaps and mid flaps separate and the fore flaps do not extend further aft but are rotated relative to the mid flap by cam action of the sequence carriages against the flap carriages.



### **Mid flaps**

The mid flaps consist of three spars and honeycomb skin panels. The mid flaps are connected directly to flap carriages which ride on the flap tracks. The mid flaps are also connected to the flap transmission ball screw. Additional rollers on the ends of the mid flap contact tracks on wing structure to provide deflection control.

### **Aft flaps**

The aft flaps are constructed in the same manner as the fore flaps. The aft flaps are supported by trunnion-mounted tubes which are connected through fittings to the mid flap rear spar.

### **Flap Carriage**

Two flap carriages support each trailing edge flap. The aft end of the flap carriages extends into the nose of the mid flap. The flap carriage is positioned in the mid flap

by two steel bearings. The aft bearing is adjustable to control the flap trailing edge vertical position and is not rigid, which allows the carriage to move relative to the mid flap during flap operation. The carriage is retained by thrust collars, washers, and nuts. As the flaps are driven by the transmissions, the flap carriages travel along the flap tracks on roller bearings holding the flaps in the desired position.

### **Flap Sequence Carriage**

Two sequence carriages are attached to each fore flap. The sequence carriages are constructed of aluminium and steel forgings. The sequence carriages travel on roller bearings on the upper flange of the flap tracks. As the flaps extend, the sequence carriages are held in position by detent in the flap carriages and travel with them. At approximately 5 degrees of flap extension, the sequence carriages contact stops on the flap tracks. The stops prevent further aft travel of the fore flap causing the fore flap and mid flap to separate. The angle of the fore flap is controlled by the fore flap tracks as they extend into and retract out of the mid flap assembly.



### **Flap Tracks and Fairings**

- Each flap is mounted to two flap tracks. The flap tracks are curved, forged steel beams which attach to the lower surface of the wing. A flap transmission is

mounted on each flap track. The flap tracks and transmissions are housed in aerodynamic fairings.

- Each fairing consists of two parts. The forward section is rigidly attached to the wing. The aft section rotates about a hinge support on the flap track. The fairings are constructed of aluminium frames covered with epoxy reinforced fiberglass honeycomb. The fairings are actuated by a fairing drive mechanism linkage and control rod. As the flaps move, the drive mechanism pivots about the end of the flap track and positions the fairing in the proper relationship with the flap. Access panels are provided on the fairing to facilitate system adjustment.

## **Operation**

### Functional Description - High Lift System

- The high lift system is normally driven by hydraulic power for the TE flaps and pneumatic power for the LE flaps. Hydraulic system 1 provides power for the inboard TE flaps, and hydraulic system 4 provides power for the outboard TE flaps.
- The flaps are controlled in 4 groups: TE inboard, TE outboard, LE group A (the 8 inboard LE flaps on each wing), and LE group B (the 6 outboard LE flaps on each wing). Each group can be independently driven by electric motors if the group fails to move under hydraulic or pneumatic power.
- Each flap group can operate independently in the primary hydraulic/pneumatic mode, or the primary electric mode, or together in the alternate electric mode. In either of the primary operating modes, flap movement is controlled by the Flap Control Unit (FCU) based on the position of the flap control lever. In alternate electric mode, flap movement is controlled from the alternate flaps control switches.

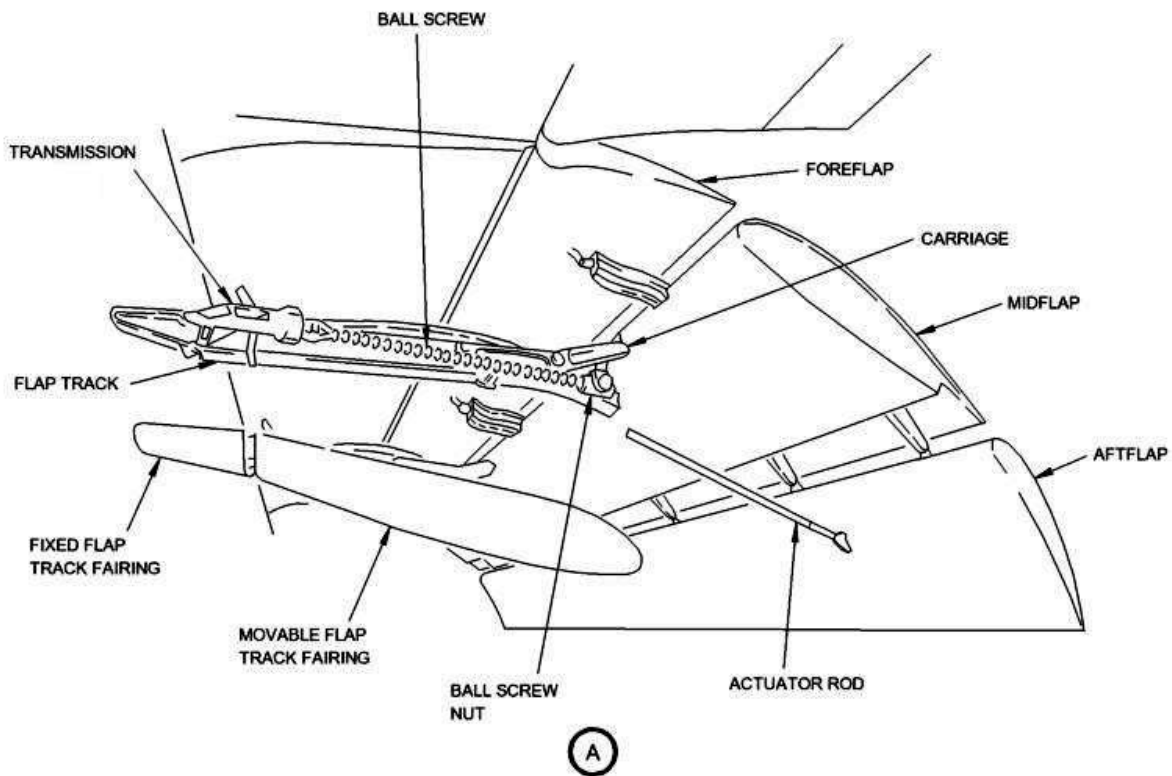
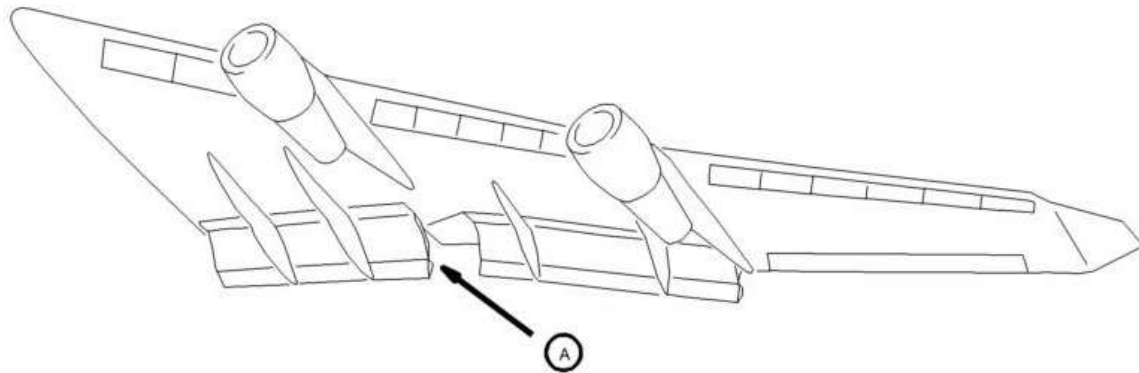

***Trailing Edge Flap System***

When the flaps are extended, they moves aft away from the wing and then down. The flap segments remains together until about 5° of extension (Flap 5), when the fore flap segment stops moving aft but rotates, and the main flap (mid flap) begins to separate from the fore flap. The fore flap rotation is controlled from Flap 5 to Flap 30 by the fore flap (mid flap) tracks. Just past Flap 20, as the main flap continues to extend, the aft flap began to separate from the mid flap until Flap 30

when the flaps are fully extended. The reverse occurs during retraction, where the mid flap picks up the fore flap and pushes it to its retracted position tucked beneath the aft section of the wing. In its retracted position the fore flap is sheltered from the normal airflow by the wing. The aircraft manufacturer only classified the mid flap as the primary structure.

### 1.6.3 General information

- a) Aircraft Model : B747-467F
- b) Aircraft SL. No. : 30804
- c) Year of Manufacturer : 2000
- d) Owner & operator : Cathay Pacific Airways Limited
- e) C of R : 486, Hong Kong CAD
- f) C of A : 343-14, Hong Kong CAD
- g) C of A Validity : 01<sup>st</sup> Sep 2014 to 11 Sep 2015
- h) ARC issued on : 22<sup>nd</sup> Aug 2014 (Certificate of Maintenance Review)
- i) ARC valid up to : 11<sup>th</sup> Sep 2015
- j) Aeromobile License No & Validity: 30804 (Approval of Aircraft Radio Installation)
- k) Engine Type : RB211-524GT
- l) Aircraft Empty Weight : 160206 Kgs / 353194 lbs
- m) Maximum Take-off weight : 394625 Kgs / 870000 lbs
- n) Date of Aircraft weighment : 22 Aug 2014
- o) Total aircraft (Airframe) Hours : 66584:26
- p) Last Major Inspection C/o on aircraft : C check in XMN (Xiamen Gaoqi International Airport), China on 26 Aug 2014 at 63974:17 FH
- q) Last Inspection carried out on aircraft with Date, engine & airframe hours: Daily Check in HKG (Hong Kong) on 27 Jul 2015 at 66578:56 FH

The subject Boeing 747-400 aircraft (MSN 30804) was manufactured in year 2000. The aircraft was registered with Hong Kong Civil Aviation Department (HK CAD) under the ownership of M/s Cathay Pacific Airways Limited. The aircraft is registered under the Certificate of registration No. 486.



The Certificate of Airworthiness Number 343-14, under "Transport category (Cargo)" subdivision Passenger / Mail / Goods was issued by HK - CAD (Hong Kong Civil Aviation Department) on 01<sup>st</sup> September 2014. At the time of incident the Certificate of Airworthiness was current and was valid up to 11<sup>th</sup> September 2015. After C of A, the aircraft flew 2565:38 hrs before the incident flight. The Certificate of Maintenance Review was issued on 22<sup>nd</sup> August 2014 and was valid upto 11<sup>th</sup> September 2015.

The aircraft and its Engines are being maintained as per the maintenance program consisting of calendar period/ flying Hours or Cycles based maintenance as per maintenance program approved by HK CAD. The scrutiny of the Airframe Log book revealed that as on date of incident i.e. 27.07.2015, the aircraft had completed 66584:26 Hrs and 11942 landings since new.

The aircraft was having Aeromobile License No. 30804 and was valid at the time of incident.

Last major inspection 'C' check Inspection schedule was carried out at 63974:17 Hrs on 26<sup>th</sup> August 2014 at XMN. During the 'C' check, it is required to carry out the inspection of the aircraft structural components including the condition of the trailing edge flap assembly. The same was carried out and no discrepancy was reported on the trailing edge flap assembly.

As per store records, last component replaced on the aircraft was No. 8 Main wheel assembly which was replaced on 26<sup>th</sup> July 2015.

The aircraft is powered by four RB211-524GT high bypass turbofan engines manufactured by Rolls - Royce. The details of the Engines are given below:

|               | Engine # 1  | Engine # 2  | Engine # 3  | Engine # 4  |
|---------------|-------------|-------------|-------------|-------------|
| Engine Model  | RB211-524GT | RB211-524GT | RB211-524GT | RB211-524GT |
| Serial Number | 13201       | 13085       | 13358       | 13303       |
| TSN<br>(Hrs)  | 99411:07    | 99606:41    | 75601:11    | 71260:21    |
| CSN           | 16310       | 16598       | 11740       | 10473       |

The aircraft was last weighed on 22<sup>nd</sup> August 2014 at XMN and the weight schedule was prepared and duly approved in accordance with M/s Cathay Pacific Airways (CPA) procedures approved by the HK CAD. As per the approved weight schedule the empty weight of the aircraft is 160206 Kgs. Maximum Usable fuel Quantity is 174093 Kgs. Maximum payload with full fuel tanks is 67456 Kgs. Empty weight CG is 1359.593 inches aft of datum. The next weighing was due on 21<sup>st</sup> August 2019.

#### **1.6.4 Airworthiness Directive, Service Bulletins & Its Compliance**

An Airworthiness Directive (AD) is a directive issued when the Airworthiness Authority relevant to the State of the Type Certificate (TC) Holder (in the present case it is Federal Aviation Administration (FAA)) or State of Aircraft Registration realizes that an unsafe condition exists in a product (aircraft engine, airframe, appliance or propeller). They notify aircraft operators and owners of potentially unsafe conditions that need special inspections, alterations, or repairs.

A Service Bulletin (SB) is a notice to aircraft operators from a manufacturer informing them of a product improvement. An alert service bulletin is issued when an unsafe condition shows up that the manufacturer believes to be a safety related as opposed to a mere improvement of a product. Service bulletins often result to issuance of Airworthiness Directives by the FAA. An Airworthiness Directive references the alert service bulletin as a way of complying with the AD.

There are distinct levels of seriousness to a service bulletin, and accordingly manufacturers have started to categorize them as optional, recommended, alert, mandatory, informational, etc. It was left to the manufacturers to classify a service bulletin as they considered best for there was no standard for the terminology. Differentiation between non-mandatory service bulletins is done and decided only by the FAA.

Although a service bulletin may be categorized as mandatory by the manufacturer, however its compliance is not necessarily required to be so as per

the FAR's (Federal Aviation Regulations) or by regulations of concerned state authorities unless the service bulletin includes or is accompanied by an airworthiness directive. As opposed to service bulletins, airworthiness directives affect the safety conditions of a flight. It's for this reason its compliance becomes mandatory.

So, just because the FAA doesn't necessarily mandate the compliance of Service Bulletins, doesn't imply that an aircraft owner/operator can overlook service bulletins. The inaction/non-compliance may lead to serious safety issue which consequently may result in any occurrence of serious nature at some time in the future. Therefore, it is always safe to comply with the service bulletin specially those which require only performing more detailed inspection and does not require replacement of any component which may translate into higher cost to the aircraft owner/operator. It is therefore very important to realise that manufacturers issue service bulletins because they believe that its compliance will make their products safer.

#### **1.6.5 Service Bulletin 747-27-2366**

In order to ensure continued reliable operation of the inboard and outboard trailing edge fore flap system, the aircraft manufacturer had issued Service Bulletin (SB) 747-27-2366 which was initially issued on 22<sup>nd</sup> December 1998 and was later revised as revision 1 on 13<sup>th</sup> December 2001. As there was numerous reports of damage to the fore flap and associated components due to skewed operation of the fore flap assembly in flight which in most of the cases, has resulted in fore flap separation it was considered as the 'known mode of failure'. Based on this, the manufacturer had further revised the SB 747-27-2366 as revision 2 which was issued on 3<sup>rd</sup> August 2011.

The service bulletin presents a compilation of the recommended service bulletins and routine system maintenance tasks that when accomplished, will allow maximum inboard and outboard trailing edge fore flap system reliability. The inspection will prevent fore flap malfunction and abnormal loading that can

develop from wear and the accumulation of debris resulting in seized and broken rollers. If this service bulletin is not performed, debris from seized or broken fore flap rollers could result in the fracture of the fore flap attachment fittings and subsequent loss of the fore flap.

As per the SB the manufacturer has recommended inspection intervals as below:

| <b>Work Package #</b> | <b>Interval Time</b> |
|-----------------------|----------------------|
| 1                     | 06 Months            |
| 2                     | 18 months            |
| 3                     | 08 years             |

The operator did not comply with the service bulletin as it was not mandated by FAA and nor by HK-CAD. However, after the incident, as per aircraft manufacturer's advice, CPA Engineering had taken steps to incorporate repetitive inspection and lubrication to trailing edge flap system in accordance with Boeing SB 747-27-2366 Revision 2 work packages.

To enhance the maintenance of TE fore flap system so that to increase its durability, the manufacturer has issued Revision 3 to SB 747-27-2366 on 22<sup>nd</sup> March 2016. This Revision 3 of SB requires detailed inspections and lubrication of TE flap system and its associated components as per the intervals mentioned above.

## **1.7 Meteorological Information**

At the time of incident at IGI Airport, Delhi, following meteorological conditions existed.

| Time (UTC) | Winds (°/Kts) | Visibility (meters) | Clouds    | Temp (°C) | Dew Point (°C) | QNH (hPa) |
|------------|---------------|---------------------|-----------|-----------|----------------|-----------|
| 1200       | 120/10        | 4000                | SCT 350 m | 33        | 24             | 1000      |
| 1300       | 110/07        | 3500                | SCT 350 m | 30        | 26             | 1000      |
| 1330       | 130/05        | 3500                | SCT 350 m | 30        | 26             | 1000      |

## 1.8 Aids to Navigation

The IGI Airport, New Delhi has 03 runways and are equipped with NDB, DVOR, ILS CAT-I, CAT-II, CAT-IIIA, CAT-IIIB, ASMGCS, SMR.

## 1.9 Communications

There was always two ways communication between the ATC and the aircraft. At the time of incident, the aircraft was under control of Delhi ATC.

## 1.10 Aerodrome Information

The aircraft landed on runway 10 of IGI Airport, New Delhi. The details of the IGI airport New Delhi are as follows:

### Co-ordinates

ARP : N 28° 34' 07"  
E 077° 06' 44"

Elevation : 778 Feet.

### Runway Orientation and Dimension

Orientation - 10/28 Dimension 3810 x 45 Meters

11/29 Dimension 4430 x 60 Meters

09/27 Dimension 2813 x 45 Meters

### Approach and Runway Lighting

| RWY. | APCH LGT | THR LGT | PAPI | Rwy Centre Line LGT | RWY edge LGT |
|------|----------|---------|------|---------------------|--------------|
| 09   | SALS     | Yes     | Yes  | Yes                 | Yes          |
| 27   | CAT-I    | Yes     | Yes  | Yes                 | Yes          |
| 10   | CAT-I    | Yes     | Yes  | Yes                 | Yes          |
| 28   | CAT IIIB | Yes     | Yes  | Yes                 | Yes          |
| 11   | CAT IIIB | Yes     | Yes  | Yes                 | Yes          |
| 29   | CAT IIIB | Yes     | Yes  | Yes                 | Yes          |

ATS Airspace:

- |                            |                                     |
|----------------------------|-------------------------------------|
| a. Designation             | Delhi CTR. 30 NM centred at DPN VOR |
| b. Vertical Limits         | SFC to FL50                         |
| c. Airspace Classification | D                                   |
| d. Transition Altitude     | 4000 FT MSL                         |

Fire Fighting Services: CAT – 10

Met Services

Met Office Hour of service is 24 Hrs. TAF, Trend Forecast and Briefing is available.

Navigation and Landing Aids

NDB, DVOR, ILS CAT-I, CAT-II, CAT-IIIA, CAT-IIIB, ASMGCS, SMR

ATS Communication Facilities

|                      |                                       |
|----------------------|---------------------------------------|
| Delhi Radar          | 119.3/127.9 MHZ                       |
| Delhi Flow Control   | 119.5 MHZ                             |
| Delhi Approach       | 119.3/127.9 MHZ                       |
| Delhi Approach/Radar | 124.2/124.25/124.6/125.675/125.85 MHZ |
| Delhi Tower          | 118.1/118.25/118.75/118.825 MHZ       |
| DATIS                | 126.4 MHZ                             |
| Delhi Ground         | 121.625/121.75/121.9 MHZ              |

**1.11 Flight Recorders**

Both Solid State Cockpit Voice Recorder (SSCVR) and Solid State Flight Data Recorder (SSFDR) were downloaded and readout carried out.

The CVR circuit breaker was not pulled immediately after the incident as the CPA Engineering Organisation Maintenance Practices (EOMP) does not require the CVR circuit breaker to be pulled unless an accident is declared. The CVR records, whenever it is powered from the electrical essential bus. The CVR

playback revealed that it had only captured the Delhi Ground controller's communications while some maintenance work was carried out in the aircraft post incident.

The DFDR was removed from the aircraft and the data was retrieved. Relevant data was analysed and there were no abnormalities observed. There was no warning in the cockpit and the landing was normal. The slats and flaps extended and retracted normally.

### **1.12 Wreckage and Impact Information**

During landing at Delhi the left inboard trailing edge fore flap separated from the aircraft. The separated fore flap was later recovered from the runway by DIAL personnel after getting information from ATC about the same. In addition sweeping of runway and taxiway was carried out in order to confirm no other parts were separated from the aircraft. On visual examination of the separated fore flap and the aircraft following observations were made:

- The fore flap was broken into three span wise pieces after impacting with the runway.
- **Mid flap track & fore flap track (Mid flap track linkage with fore flap)**
  - The outboard mid flap track (which supports the fore flap and extends into the mid flap) was found attached to the fore flap track (which is attached to lower surface of fore flap). The outboard mid flap track was found broken at the aft end (point of attachment with mid flap) which resulted into its separation from the mid flap. Only a piece of fractured end segment of the mid flap track was recovered from inside mid flap. The mid flap cut out (outboard) at leading edge for mid flap – fore flap track was found ruptured and part of upper skin missing.



- The centre mid flap track was found attached with the mid flap, however was found slightly bent due to overload. The fore flap track was broken from its aft end (point of attachment with mid flap track). The broken end segment of fore flap track was found attached to the mid flap track along with bolt and nut. The mid flap cut out lower skin was found ruptured.





- The inboard mid flap track was also found attached with the mid flap and like centre fore flap track, the inboard fore flap track was found broken from aft end. The broken end segment of fore flap track was found attached to the mid flap track along with bolt and nut. Bull Nose of about 24 Inches from inboard edge was found missing and Inboard Mid Flap Cut out skin was partially ripped off.



➤ **Fore flap sequence carriage and fore flap inner attachment link**

- The # 3 (outboard) sequence carriage assembly was found intact on flap track. The fore flap attachment link (with carriage) was found broken from attachment eye end. The broken end segment of fore flap attachment link was missing. However the self-aligning mono-ball bearing of link was found attached to the sequence carriage.



- The # 4 (inboard) sequence carriage was found intact on flap track. However the carriage linkage (with fore flap attachment link) was found broken and separated from the carriage. The broken segment was found attached with fore flap link along with attachment bolt & mono ball bearing. The detent roller was found broken and separated from carriage. The carriage slide on the flap track without roller as evident from the friction marks observed on the upper flange of flap track. The detent roller was recovered from the inner flap track fairing.





- Scratches were observed on the Flap Stowage Bracket Track probably due to separation of outboard mid flap track from mid flap causing the fore flap to come in contact with adjacent surface.



- The fore flap separation caused damage to mid flap skin and honeycomb.



- There was no damage observed on the other parts of aircraft structure due to separation of fore flap.

### **1.13 Medical and Pathological Information**

Crew had undergone Pre-flight Medical i.e. Breath Analyser Test on the day before the first flight of the day at Hong Kong and were found not under the influence of alcohol.

### **1.14 Fire**

There was no fire.

### **1.15 Survival Aspects**

The incident was survivable.

### **1.16 Tests and Research:**

After the incident some of the damaged aircraft parts were recovered from the aircraft and out of these, some items were later released to Cathay Pacific Airways (CPA), Hong Kong for further transportation to NTSB, USA for detailed examination in order to find out the cause of the failure. During transit of the shipment in Hong Kong, three of the four items that were to be sent onward for examination by the NTSB, USA were lost.

CPA Engineering and HAECO (CPA's MRO in Hong Kong) investigated the circumstances that lead to the loss of the items. It was found that during handling of the shipment in HAECO, three of the four items were mistakenly identified as 'scrap' and disposed of. The missing items were considered lost after all reasonable efforts to recover them were exhausted. The remaining 01 item i.e. the LH wing mid flap track (outboard position) was further sent to NTSB, USA for detailed examination.

Observations made during the examination of LH wing mid flap track are as follows:

The lower flange at the aft end of the track was fractured, optical examination of the fracture faces found markings and adjacent deformation patterns indicating a bending overstress separation. The bending direction was as if the aft end of the track bent upward. No indications of pre-existing cracking or corrosion were noted on the fracture or other locations on the track. The lower running surface of the track near the fracture had a local deformation on the outboard side. The overall track also had a slight longitudinal twist and a slight sideways bend.



*The lower flange at the aft end of the track was fractured*

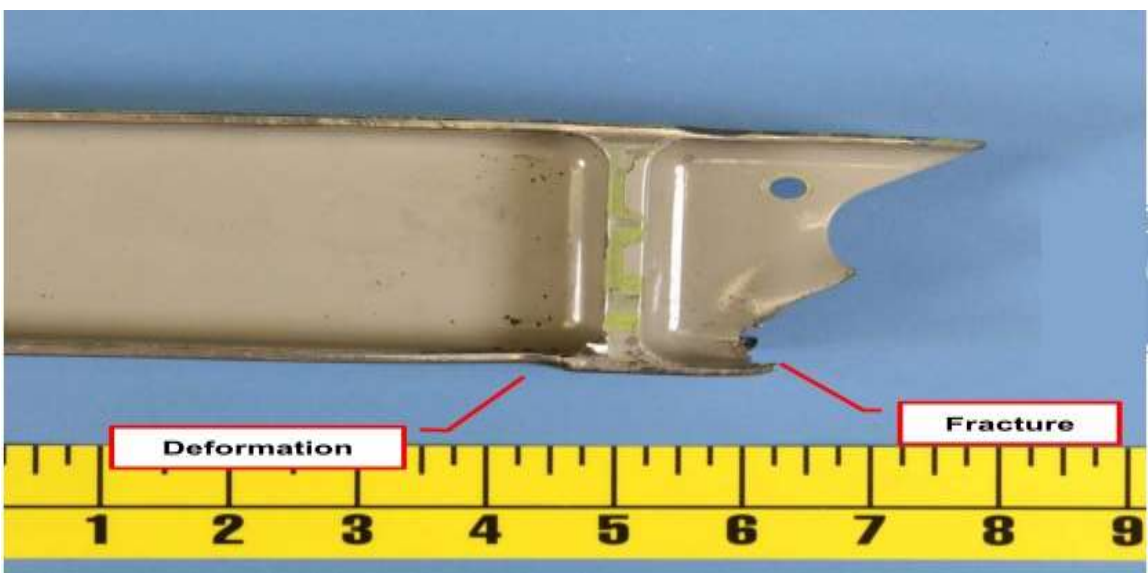

*Close view of the fractured end*

## **1.17 Organizational and Management Information**

The operator has been issued with an Air Operator's Certificate by Hong Kong – Civil Aviation Department and was valid on the date of incident. The aircraft maintenance is carried out by HAECO (Hong Kong Aircraft Engineering Co. Ltd.) which is the operator's MRO situated in Hong Kong.

Cathay Pacific Airways is a scheduled operator which has its main base at Hong Kong, China. The Cathay Pacific Group operates more than 150 aircraft to some 130 destinations across the globe. The Cathay Pacific has fleet of approximately 146 wide-body aircraft. The fleet combines of 777-300ER, Airbus 350 – 900 with Boeing 747-400 "Extended Range Freighters" and New-Generation Boeing 747-8F.

## **1.18 Additional information:**

### **1.18.1 Occurrences of trailing edge fore flap failure worldwide**

As this was not the first instance of trailing edge fore flap failure during flight, the committee decided to study and analyse similar events of fore flap separation during flight that occurred worldwide on Boeing 747-400 aircraft of different operators. The purpose of the study was to observe the mode of failures of these events and to analyse the same with the subject event so that some possible scenarios can be derived in the absence of conclusive evidences.

Some of the occurrences referred are as follows:

- On 7th June 1997 a Boeing 747-400 aircraft was on approach to land, when a portion of inboard trailing edge fore flap separated from the aircraft. As in the present case the aircraft landed without getting any warning/signal in the cockpit. But during the post landing inspection it was observed that 60% of the fore flap was missing.

During the investigation it was found that the incident occurred due to failure of inboard fore flap link (attachment with sequence carriage).

- On 30th August 2002 a Boeing 747-400 aircraft took-off from runway and during a left turn shortly after departure, with the flaps still extended to the take-off setting, about 70% of the right inboard trailing edge fore flap separated from the aircraft. The pilots did not receive any cockpit indications and only felt some slight bumps, which they thought to be some turbulence. The flight crew were unaware of the separation until the landing approach after about 12 hours of flight. The crew took appropriate actions and the aircraft landed safely.

During the investigation it was found that the flap separated due to failure of inboard fore flap inner attachment link. The link failed due to a pre-existing stress corrosion crack that had grown to a critical size. Post this incident and in view of the similar incidents in near past the aircraft manufacturer made a design change to overcome the limitations of the fore flap attachment links.

- On 19th May 2013 a Boeing 747-400 aircraft a cargo flight during approach to runway just after pilot selected flaps 30, experienced a partial separation of the right inboard fore flap. The flight crew performed a go around and landed safely. The pieces of the fore flap were later recovered from buildings and the ground in the area below the approach path.

During the investigation it was found that the fore flap separated due to fatigue and bearing anomalies on the sequence carriages.

Apart from the above events few other instances of fore flap separation were also considered. In all the above events the fore flap was separated from the aircraft during flight (landing or take-off) when the flaps were extended to its optimum. The primary cause of separation of fore flap for most of the cases was observed to be the failure of one of the fore flap inner attachment link (with sequence carriage) or anomalies in the sequence carriage(s) and its associated components. On observing the repetitive nature of fore flap inner attachment link failure, the manufacturer in 2003, altered the design of the fore flap attachment

fittings to prevent such failures. Also, in all the above cases including the present case the separation of fore flap did not compromise with the safety of the aircraft.

**1.19 Useful or Effective Investigation Techniques: Nil**

**2. ANALYSIS:**

**2.1 Serviceability of the aircraft**

2.1.1 The aircraft was manufactured in the year 2000. The certificate of registry and certificate of airworthiness were valid on the day of incident. The Certificate of maintenance review was valid upto 11th September 2015. The aircraft had flown 66584:26 Hrs/ 11942 landings since new and 2565:38 hrs after issue of last C of A, before the incident flight.

The aircraft and its Engines were maintained as per the maintenance program consisting of calendar period/ flying Hours or Cycles based maintenance as per maintenance program approved by HK CAD. The scrutiny of the Airframe Log book revealed that as on date of incident i.e. 27.07.2015, the aircraft had completed 66584:26 Hrs and 11942 landings since new.

Last major inspection 'C' check Inspection schedule was carried out at 63974:17 Hrs on 26th August 2014 at XMN (Xiamen Gaoqi International Airport), China. During the 'C' check, inspection of the condition of the trailing edge flap assembly was carried out and no discrepancy was reported on the same.

The scrutiny of the records revealed that there was no defect reported on the flaps/flap mechanisms and its associated components before the incident.

2.1.2 In order to ensure continued reliable operation of the inboard and outboard trailing edge fore flap system of B747 aircraft, the manufacturer had issued Service Bulletin (SB) 747-27-2366 Revision 2 considering the 'known mode of failure' which was based on the numerous reports of failure of fore flap and its



associated components. The service bulletin calls for detailed inspections & lubrication of inboard & outboard TE fore flap system for atleast every 06 months. The incorporation of SB, which is a good maintenance practice, will allow maximum reliability & safety which subsequently could have prevented fore flap malfunction. The operator did not comply with the service bulletin as it was not mandated by FAA and nor by HK-CAD. The Non-compliance of this SB may have resulted in malfunction of trailing edge fore flap system which subsequently led to the incident.

## **2.2 Weather**

At the time of incident, the visibility was 3500 meters with winds 110°/07 Kts, temperature 30° C, Dew point 26°, QNH 1000 and clouds SCT 350 m.

In view of the above the weather at the time of incident was fine and is not a contributory factor to the incident.

## **2.3 Pilot Factor**

Both the cockpit crew were qualified to operate the subject flight. The PIC and the co-pilot both were holding a valid ATPL license and were qualified on type. Both the crew were current in all the trainings and ratings as per the requirements. The PIC had total flying experience of more than 9,500 hours with approximately 4600 hours on type and about 2200 hours as PIC on type. The co-pilot had total flying experience of about 9216 hours and approximately 3000 hours on type.

The aircraft was cleared for landing at Delhi. The crew then correctly configured the aircraft for landing and the flaps were selected to Flaps 30 (fully extended). There was no signal/indication in the cockpit and the crew did not experience any control abnormalities, during landing. Hence, the flight crew were not aware that the fore flap had separated from the aircraft during landing and carried out taxi & subsequent operations normally. When the aircraft was taxing in, the ground

controller contacted them and informed that a part had separated from the aircraft during the landing. After parking the aircraft on bay, the flight crew instructed the Delhi ground engineer to perform a walk around inspection but this initially revealed no missing parts. The flight crew then fully extended the wing flaps, after which the engineer reported that the left wing inboard trailing edge fore-flap was missing. They then informed the ATC about the same.

#### **2.4 Circumstances leading to the incident:**

The aircraft took off from Hong Kong at 1240 UTC and during take-off there was no abnormality observed by the pilot. After about 06 hours of uneventful flight, the aircraft approached Delhi. The aircraft was cleared for landing and accordingly it was configured for landing with flaps fully extended i.e. flaps 30. During landing the left inboard trailing edge fore flap separated from the aircraft and fell on runway.

After the incident some of the damaged aircraft parts were recovered from the aircraft for detailed examination in order to find out the cause of the failure. During transit of the shipment in Hong Kong, three of the four items that were to be sent onward for examination by the NTSB, USA were lost. Only the outboard mid-flap track was available for examination by the NTSB, USA. Hence the exact cause of the failure could not be determined.

In view of the above the committee analysed the available evidences, the damage pattern and also studied & analysed the similar events of fore flap separation during flight that occurred on Boeing B747 aircraft (different operators) worldwide. Based on the same the committee deliberated on the possible circumstances which could have led to the failure of the fore flap and the incident.

As discussed earlier the trailing edge fore flap is mainly supported by three mid flap tracks which extends into the mid flap. One end of the mid flap track is attached to a linkage whose one end is attached to lower surface of fore flap. The fore flap is also attached to two sequence carriages with the help of an inner

link. Therefore, the fore flap has total of five attachment links with the airframe and as the entire fore flap had separated from the aircraft, depicts that all the five attachment links failed during the flight, though primarily one (or two) of them would have failed causing others to fail consequently. Hence possibility of failure of each link and its associated parts was considered and is discussed below:

### **Mid flap Track & Fore flap links**

There are three mid flap tracks that supports the fore flap through a link which is attached to lower surface of fore flap. Two of the three mid flap tracks (inboard and centre) were found attached to the mid flap. However, their respective attachment fore flap links were found fractured from the aft end i.e. near the attachment end with mid flap track and were separated along with the fore flap. On analysing (visually) the aft damaged segment of these links which was found attached with mid flap track along with bolt & nut, the damages were observed to be fresh in nature, depicting that the damages may have been consequential. Also being designed strong to withstand air loads, the probability of these links to fail primarily is improbable.

The third mid flap track i.e. the outboard one was fractured from the aft end and was separated from the mid flap along with the fore flap. The track was found attached with the fore flap. The track was examined in detail by NTSB, USA and optical examination of the fractured faces was carried out. The markings and adjacent deformation patterns on the fractured faces indicated that it separated due to bending overstress. The bending direction was as if the aft end of the track bent upward. There was no indication of pre-existing cracking or corrosion on the fractured face or other locations on the track. The track also had a slight longitudinal twist and a slight sideways bent. This depicts that after the flaps were extended fully during landing, all the other adjacent fore flap support link(s) may have failed before the outboard mid flap track. Hence, all the air loads on the fore flap was mainly supported by the outboard mid flap track which eventually got fractured due to bending overstress. In addition to the above, the damages to the cut out (outboard) at leading edge of mid flap (for mid flap track) which was found ruptured along with part of upper skin missing and the scratch marks observed

on the flap stowage bracket track & its adjacent surface also indicates that the fore flap was floating in the air mainly with the support of outboard mid flap track after the other attachment link(s) failed. In view of the above it may be concluded that fracture of outboard mid flap track was not the primary failure for the fore flap separation.

### **Fore flap inner link**

As discussed earlier the fore flap is attached to sequence carriage with the help of fore flap inner link. This inner link is considered as the weakest link and has the highest probability of failure among all the fore flap links. The same was also observed during the study of similar events of fore flap separation which occurred on B747 aircraft worldwide. In most of the events the primary cause of the event was the failure of one of the fore flap inner link which resulted in separation of the fore flap from the aircraft during flight (landing & take-off). In the present case also the outboard fore flap inner link (attached to outboard sequence carriage) was found fractured and got separated from the carriage attachment. This fractured inner link may have led to failure of other links one after another under severe air loads when the flaps were extended fully for landing, thereby causing the fore flap to separate from the aircraft. Hence it is highly probable that the failure of outboard fore flap inner link may be the primary failure.

Fracture of a fore flap attachment link would not necessarily result in immediate partial or complete loss of the fore flap. Because of the design, it is possible for the fore flap to remain functional for an indeterminate period with a fractured link.

The other fore flap inner link i.e. the inboard one was found intact and attached with the fore flap along with the bolt & nuts.

### **The Inboard Sequence Carriage & Detent roller**

The inboard sequence carriage was found intact with the flap track. However while inspecting the carriage it was found that the attachment lug (attachment with fore flap inner link) was fractured and the fractured segment of the lug was

found attached with the fore flap inner link along with bolt, nut, washers and bushings. The detent roller of the carriage was also found sheared and separated from the carriage assembly. Friction marks were observed on the flap track which indicates that when the flaps were extended the sequence carriage moved on the flap track for some distance after the detent roller was separated. This reveals that there may be some anomalies in the inboard sequence carriage assembly thereby resulting in inboard sequence carriage getting out of phase with the other sequence carriage. This may have led to fracture of carriage attachment lug (attachment with fore flap inner link) or the outboard fore flap inner link and subsequently led to failure of other links one after another under severe air loads when the flaps were extended fully for landing. Hence anomalies in sequence carriages may be the primary reason for failure/fracture of carriage attachment lug and fore flap inner attachment link.

#### **SB 747-272366**

The above failures discussed may be consequential as Boeing SB 747-272366 Revision 2 calls for detailed inspection and lubrication of fore flap and associated components. The SB was not complied by the operator as it was not mandated by FAA and nor by the HK-CAD which may have led to skewed operation of fore flap assembly. The skewed operation of the fore flap assembly in flight can be caused by worn or broken centre toggle rollers or by binding of the fore flap track rollers in the mid flap. This lead to accumulation of debris from seized or broken fore flap rollers. This debris could result in the fracture of the fore flap attachment fittings (as discussed above) and subsequent separation of the fore flap.

In view of the above the committee has concluded that if the SB had been complied, the failure of any of the trailing edge fore flap components could have been timely traced and the occurrence could have been avoided.

### **3. CONCLUSIONS:**

#### **3.1 Findings:**

- 1) The certificate of Airworthiness, Certificate of Registration, and CRS of the aircraft was valid on the date of incident.
- 2) The aircraft was certified and maintained in accordance with prescribed procedures.
- 3) The CG of the aircraft was within the prescribed limits. There was no snag reported on the aircraft prior to the incident flight.
- 4) Last major inspection 'C' check Inspection schedule on the aircraft was carried out at 63974:17 Hrs on 26th August 2014 at XMN. During the 'C' check no discrepancy was reported on the trailing edge flap assembly.
- 5) All navigational and approach aids were functional and were operating normally at the time of incident.
- 6) The PIC & Co-pilot had undergone the requisite pre-flight medical examination and were certified as not being under the influence of alcohol.
- 7) The PIC had a total flying hours of about 9,500 Hrs of which 4600 hrs were on type and 2212 Hrs as PIC on type. Co-Pilot had a total flying experience of 9216 hrs and approximately 3000 hrs as PIC on type. Both the cockpit crew were qualified to operate the subject flight.
- 8) The aircraft took off from Hong Kong at 1240 UTC and during take-off there was no abnormality observed by the pilot. After about 06 hours of uneventful flight, the aircraft approached Delhi.
- 9) The aircraft was cleared for landing and accordingly the crew correctly configured the aircraft for landing with flaps fully extended i.e. flaps 30.
- 10) During landing the left inboard trailing edge fore flap separated from the aircraft and fell on runway.
- 11) There was no signal/indication in the cockpit and the crew did not experience any control abnormalities, during landing. Hence, the flight crew were not aware that the fore flap had separated from the aircraft during landing.
- 12) The crew carried out taxi & subsequent operations normally.

- 13) When the aircraft was taxiing in, the ground ATC contacted them and informed that a part had departed the aircraft during the landing.
- 14) After parking the aircraft on bay, the flight crew instructed the ground engineer to perform a walk around inspection and after fully extending the flaps the engineer reported that the left wing inboard trailing edge fore-flap was missing.
- 15) The flight crew then informed the ATC about the same.
- 16) The fore flap was recovered from the runway and was found broken into three pieces.
- 17) There was no injury and there was no fire during the incident.
- 18) Some of the damaged parts were recovered after the incident for further detailed examination. During transit of the shipment of damaged parts in Hong Kong, three of the four items that were to be sent onward for examination by the NTSB, USA were lost.
- 19) During handling of the shipment in HAECO, three of the four items were mistakenly identified as 'scrap' and disposed of. The missing B-HUL items were considered lost after all reasonable efforts to recover them were exhausted. Only the LH wing mid flap track (outboard position) was further shipped to NTSB, USA for detailed examination.
- 20) The fore flap has total of five attachment links with the airframe and as the entire fore flap had separated from the aircraft, depicts that all the five attachment links failed during the flight, though primarily one (or two) of them would have failed causing others to fail consequently.
- 21) Examination of the LH wing mid flap track revealed that it sustained bending overstress separation. The bending direction was as if the aft end of the track bent upward. There were no indications of pre-existing cracking or corrosion was noted on the fracture or other locations on the track.
- 22) It indicated that the fore flap was floating in the air mainly with the support of outboard mid flap track after the other attachment link(s) failed and may be concluded that fracture of outboard mid flap track was not the primary failure for the fore flap separation. Hence it is not the primary failure for the fore flap separation.

- 23) Other mid flap tracks (inboard and centre) was found attached to the mid flap. However, their respective attachment fore flap links were fractured, though the damages were observed to be fresh in nature, which indicates that it may have been consequential. The probability of these links to fail primarily is slightly improbable.
- 24) The study of similar events of fore flap separation which occurred on Boeing 747 aircraft worldwide of different operators revealed that the primary cause of separation of fore flap for most of the cases was observed to be the failure of one of the fore flap inner attachment link (with sequence carriage) or anomalies in the sequence carriage(s) and its associated components.
- 25) On observing the repetitive nature of fore flap inner attachment link failure, the manufacturer in 2003, altered the design of the fore flap attachment fittings to prevent such failures.
- 26) The outboard fore flap inner link (attached to outboard sequence carriage) was found fractured and got separated from the carriage attachment. Hence it is highly probable that the failure of outboard fore flap inner link may be the primary failure which caused the other attachment links to fail one after another under severe air loads during landing.
- 27) Fracture of a fore flap attachment link would not necessarily result in immediate partial or complete loss of the fore flap. Because of the design, it is possible for the fore flap to remain functional for an indeterminate period with a fractured link.
- 28) The detent roller of the inboard sequence carriage was also found sheared and separated from the carriage assembly.
- 29) When the flaps were extended the sequence carriage moved on the flap track for some distance after the detent roller was separated. This reveals that there may be some anomalies in the inboard sequence carriage assembly thereby resulting in inboard sequence carriage getting out of phase with the other sequence carriage. This may have led to fracture of carriage attachment lug (attachment with fore flap inner link) or the outboard fore flap inner link.



- 30) Based on numerous reports of damage to the fore flap and associated components the manufacturer considered the failure as the 'known mode of failure'. Based on this the manufacturer had revised the SB 747-27-2366 as revision 2 issued on 3<sup>rd</sup> August 2011.
- 31) The SB was not complied by the operator as it was not mandated by FAA and nor by the HK-CAD which may have led to skewed operation of fore flap assembly.
- 32) The skewed operation of the fore flap assembly in flight can be caused by worn or broken centre toggle rollers or by binding of the fore flap track rollers in the mid flap. This will lead to accumulation of debris from seized or broken fore flap rollers. This debris could result in the fracture of the fore flap attachment fittings and subsequent separation of the fore flap
- 33) The accumulation of debris from seized or broken fore flap rollers could result in the fracture of the fore flap attachment fittings and subsequent loss of the fore flap.
- 34) At the time of incident the weather was fine and did not contributed to the incident.

### **3.2 Probable cause of the incident:**

The incident may have occurred due to non-compliance of SB 747-27-2366 by the operator which resulted in fracture of fore flap inner attachment link (outboard) or the carriage attachment lug (inboard) leading to subsequent separation of the fore flap.

The SB 747-27-2366 was not mandated by FAA & accordingly neither by HK-CAD which may have prompted the operator to not incorporate it in their maintenance programme.

**4. SAFETY RECOMMENDATIONS:**

SB 747-27-2366 Revision 3 issued by aircraft manufacturer covers the maintenance of Trailing edge fore flap system & increase its durability providing a long term solution necessary to prevent similar failures. Hence no safety recommendations were considered necessary.

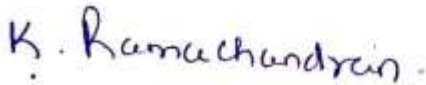
  
(K Ramachandran)  
Member, Committee of Inquiry

  
(Raje Bhatnagar)  
Chairman, Committee of Inquiry

Place : New Delhi  
Date : 27.07.2018