



AIRCRAFT ACCIDENT INVESTIGATION BUREAU

**FINAL INVESTIGATION REPORT ON SERIOUS INCIDENT
TO
AIRBUS A-320 AIRCRAFT VT-IEW
AT
MUMBAI AIRPORT
ON
9th MARCH 2013**

**MINISTRY OF CIVIL AVIATION
GOVERNMENT OF INDIA
NEW DELHI (INDIA)**

REPORT OF SERIOUS INCIDENT TO AIRBUS A-320 AIRCRAFT
VT-IEW ON 09TH MARCH 2013 AT MUMBAI.

1. Aircraft-
Type : A-320
Nationality : INDIAN
Registration : VT - IEW
2. Owner/ Operator : Inter Globe Aviation Ltd. (IndiGo)
3. Pilot – in –Command : ATPL HOLDER on type
Extent of injuries : Nil
4. First Officer : ATPL Holder on type
Extent of injuries : Nil
5. Place of Incident : Mumbai
6. Date & Time of Incident : 09th Mar 2013; 1305 UTC
7. Last point of Departure : Chandigarh
8. Point of intended landing : Mumbai
9. Type of operation : Scheduled Operation
10. Total crew on Board : 08
11. Passengers on Board : 143
Extent of injuries : Nil
12. Phase of operation : Landing
13. Type of incident : Runway Excursion

AAIB (India) Report No. : 2013-INC-

File No. AV.15020/02/2013-AAIB

Published on:

In accordance with Annex 13 to the International Civil Aviation Organisation Convention and the Aircraft (Investigation of Accidents & incidents) Rules 2012, the sole purpose of this investigation is to prevent aviation accidents. It is not the purpose of the investigation and the associated investigation report to apportion blame or liability.

Safety recommendation shall in no case create a presumption of blame or liability for an occurrence

I N D E X		
	SYNOPSIS	01
1.1	FACTUAL INFORMATION	02
1.2	History of the flight	02
1.3	Injuries to persons	05
1.4	Damage to aircraft	05
1.5	Other damage	05
1.6	Personnel information	07
1.6.1	Pilot – in – Command	07
1.6.2	Co-Pilot	08
1.7	Aircraft information	08
1.8	Meteorological information	10
1.9	Aids to navigation	11
1.10	Communications	11
1.11	Aerodrome information	11
1.12	Flight recorders	12
1.13	Wreckage and impact information	13
1.14	Medical and pathological Information	14
1.15	Fire	14
1.16	Survival aspects	14
1.17	Tests and research	15
1.18	Organizational and management information	15
1.19	Additional information:	16
1.20	Useful or effective investigation techniques	16
2.0	ANALYSIS	17

2.1	Serviceability of the aircraft	17
2.2	SSFDR/ SSCVR readouts and correlation	17
2.2.1	SSFDR	17
2.2.2	SSCVR	20
2.3	Weather	20
2.4	Pilot handling of the aircraft	21
2.5	CRM	22
2.6	Discussions on possible scenarios	22
	a. Rudder Jam	22
	b. Rudder Pedal Stiff	23
	c. Nose Wheel Steering fault	23
	d. Skidding due to rubber deposits	23
	e. Subtle-incapacitation of the Captain	23
	f. Thrust Reverser asymmetry	24
2.7	Organisation	24
2.7.1	Flight operations & training of cockpit crew	24
2.7.2	Role of Flight Safety Department	25
	a. Operational Safety Risk Assessment (OSRA)	26
	b. Flight Operations Quality Assurance (FOQA)	26
	c. FOQA Trends Report	26
2.8	Circumstances leading to the Incident (Loss of Situational Awareness & Over Correction)	26
3.0	CONCLUSIONS	27
3.1	Findings	27
3.2	Probable cause of the Incident	29
4.0	SAFETY RECOMMENDATIONS	29

SYNOPSIS:

The aircraft while operating Flight from Chandigarh to Mumbai of 09th March 2013 was involved in an incident of Runway Excursion at Mumbai during landing. During final approach at Mumbai, the aircraft was stabilized. Auto Pilot was 'ON' till 400 ft. The aircraft landed slightly to the left of centre line and veered further left of runway centre line. The left main wheels rolled over two runway edge lights and thereafter maintained trajectory close to the shoulder of the runway. The left main wheels subsequently departed the runway surface and entered the soft ground to the left, breaking five runway edge lights in the process. The aircraft was steered back onto the runway and cleared via taxiway N9. The aircraft then taxied to the bay under its own power uneventfully. There was no injury to any person on board the aircraft or on ground. There was no fire. Normal disembarkation of passengers was carried out.

Government of India vide notification no. AV.15020/02/2013-DG ordered investigation of the serious incident to Airbus A-320 aircraft VT-IEW which occurred on 09/03/2013 by a Committee of Inquiry. The intimation of the Serious Incident was provided to ICAO and BEA, France as per the requirements of ICAO Annexure 13.

Committee, after investigation opined that the incident was caused due

“The Captain got disoriented about the aircraft position with respect to runway centre line, which resulted in loss of situational awareness.

Improper use of the rudder inputs by the Captain to achieve the desired aircraft trajectory contributed to the incident.”

Certain recommendations have also been given to obviate similar occurrences in future.

1. FACTUAL INFORMATION

1.21 History of the flight

On 09th March 2013, Airbus A-320 aircraft was operating scheduled flight from Chandigarh to Mumbai. The time of departure from Chandigarh was 1617 hrs IST and the estimated time of arrival at Mumbai was 1825 hrs IST. The crew had earlier operated Mumbai-Chandigarh sector. Both the pilots had undergone Pre-flight Medical Check (PFMC) at Mumbai including Breath Analyzer (BA) test which was negative. The aircraft was cleared by engineering at Chandigarh. There were no defects / snags reported nor was any system under MEL. The take off from Chandigarh, climb, cruise and approach to Mumbai were uneventful.

During final approach at Mumbai, the aircraft was configured and stabilized. As per the pilots, they had observed strong crosswinds. Auto Pilot was 'ON' till 400 ft AGL. The flight was further uneventful till touchdown at Mumbai. The touchdown was slightly to the left of centre-line. After landing, aircraft veered further to the left of runway centre line. The left main wheels rolled over two runway edge lights and thereafter maintained trajectory close to the shoulder of the runway. The left main wheels subsequently departed the runway surface and entered the soft ground to the left, breaking five runway edge lights in the process. The aircraft was steered back onto the runway subsequently. ATC asked the aircraft to vacate via taxiway N8 but crew requested to exit via N9 and same informed to ATC. The crew has not reported any abnormality and after taxiing the aircraft was parked at assigned bay.

The pilot had informed that he has used the technique of landing in cross wind as provided by the Airbus i.e. 'Auto pilot was disconnected about 400 AGL. Auto thrust was kept 'ON'. During flare, power was reduced and rudder was used. The aircraft touched down in touch down zone slightly left of the center line (more inside towards center line then outside). When max reverser was used, there was yaw towards left edge of runway. During this, the First Officer (FO) did call his (Captain's) name and center line. As per the crew at the same

time in order to counter 'weather cocking' and prevent 'in wind' wing from lifting, they used side stick input and rudder. Captain of the aircraft reduced max reversers to idle to prevent sideways skidding as it was critical stage and he was not able to understand everything that was happening. At one point, FO said "I have control" to which the Capt. replied "I have control". The pilot further stated that,

"Having reduced reverse to idle REV used auto breaks as primary deceleration, used auto breaks and did not disconnect it. Used Captains emergency authority and used tiller two to avoid being off runway. ATC asked us to vacate N8 but I took few seconds to check system parameter and choose to exit N9. ATC asked us about reason for drifting, we informed veered left due cross wind, after taxi clearance asked landing checklist, asked FO if he noticed anything abnormal or if we veer of runway. After docking checked with cabin lead if everything ok in cabin, she mentioned one passenger complained about yaw. Went down for walk around, noticed mud at wheel # 1 on one side, same was informed to next operating crew and engineers informed of same, FSR Form submitted at dispatch and informed fleet supervisor of event."

As per the ATC tape transcript the aircraft had contacted Tower and was instructed to continue approach for runway 27. The aircraft had read back the instructions. The aircraft again contacted Tower and the Tower Controller cleared the aircraft to land on runway 27. The crew read back the instructions. These communications were loud and clear. After touchdown, the Tower Controller instructed the aircraft to vacate the runway expeditiously via N8. As per the CVR replay, the reply from the crew was blocked by simultaneous transmissions. After that the aircraft called and asked Tower to stand by. The aircraft thereafter reported vacating via N9. Tower Controller asked the aircraft if they required any assistance. The crew replied in negative.

The SMC Controller, thereafter, asked the crew, the reason for not following the centre line of the runway. The pilot reported that he thought that there were

strong cross winds. The Controller acknowledged the reply and issued further taxi instructions to stand 'A1'. The crew read back the instructions. The aircraft then taxied to the bay under its own power uneventfully.

There was no injury to any person on board the aircraft or on ground. There was no fire. Normal disembarkation of passengers was carried out.

The flow of air traffic continued normally after the flight. Later, the SMC Controller requested ATC that Follow Me jeep wanted to carry out routine inspection of Runway 27, which was permitted by ATC. Post the runway inspection the vehicle reported that 7 south side Runway 27 Edge Lights are broken between N7 and N8.

As per the MIAL Authorities tyre-marks on runway shoulder, almost upto edge of runway and unpaved area between taxiway N7 and N8 were noticed. No aircraft had reported any incident to ATC corresponding to this damage. On query, ATC informed that a particular flight had gone to the left side. MIAL authorities on arrival at the bay A1 (where the subject aircraft was parked) found that preparation were being made to change the damaged tyre.

On arrival of the aircraft at bay, the attending AME of the airline, who was deputed to carry-out transit inspection, carried out a walk-around inspection of the aircraft. During inspection, deep cuts and glass pieces embedded on # 1 Main Wheel were found. In the meantime, technician came and informed the AME that the cockpit crew has called them in the cockpit. The engineer then brought to the knowledge of the cockpit crew that there are pieces of glass embedded in the # 1 Wheel and the same has been found deflated. As per the AME, till then, the crew has not written any incident report or had made any entry in the Pilot's Defect Report (PDR). The crew then made the entry in the Tech-Log 'Landed RWY 27, Strong cross-wind, aircraft kept veering to left, had to use tiller to remain on centre.

The observations were informed to the shift incharge (engineering) by the AME. The duty engineer assessed the situation and initiated the maintenance

/ rectification action. The information of the incident was communicated to the MCC / LMM and Base Manager. Both the wheels on LH Landing Gear were replaced as per Aircraft Maintenance Manual (AMM).

Inspection of the aircraft as per the AMM requirements “after leaving runway or taxiway” was carried out and was found satisfactory. Also, CVR and DFDR were removed for further investigation.

The incident was initially not reported by the operating crew/ engineering to the Regulatory authorities as per the CAR requirements.

1.2 Injuries to persons.

INJURIES	CREW	PASSENGERS	OTHERS
FATAL	Nil	Nil	Nil
SERIOUS	Nil	Nil	Nil
MINOR/NONE	8	143	

1.3 Damage to aircraft.

No. 1 Main Wheel was found deflated and had cut marks. Glass pieces were found on the main wheel and deep cuts found on the tyre. There were signs of mud on the tyres.

1.4 Other damage:

07 Runway Edge Lights on the left side of Runway 27 (encircled in the figure below) were broken.



Deflated and damaged tyre (aircraft at parking bay)



One of the damaged runway edge light

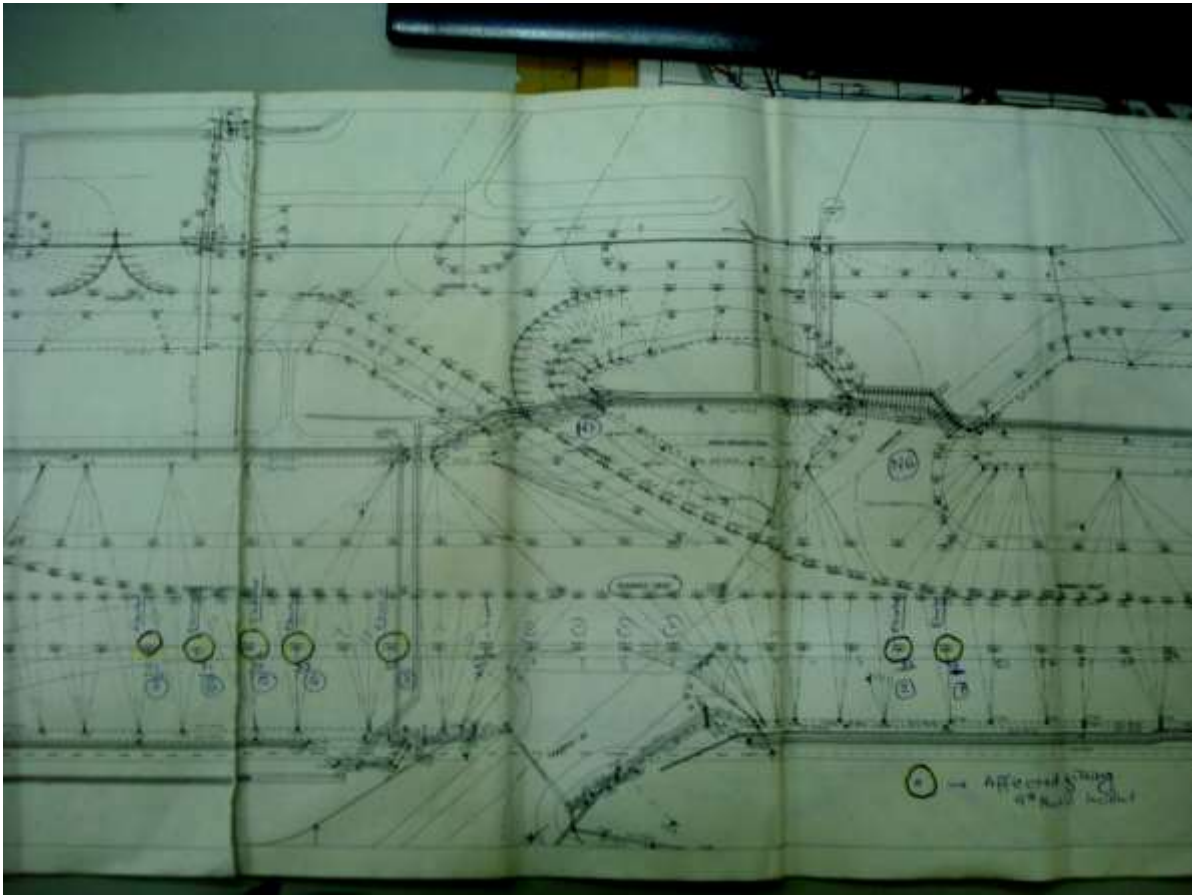

7 damaged runway edge lights (encircled)

1.5 Personnel information:

1.5.1 Pilot – in – Command:

AGE	: 28 years
Licence	: ATPL holder
Date of Issue	: 31 st May 2011
Valid up to	: 30 th May 2013
Category	: Aeroplane
Class	: Multi Engine Land
Endorsements as PIC	: Cessna 152A, Duchess 76, A319/320/321
Date of Med. Exam.	: 23/07/2012
Med. Exam valid upto	: 22/07/2013
FRTTO Licence Validity	: Valid

Total flying experience : 3071 hours
Experience on type : 2748 hours
Experience as PIC on type : 28 hours
Total flying experience during last 180 days : 302:23hours approx
Total flying experience during last 90 days : 159:08hours approx
Total flying experience during last 30 days : 54:12 hours approx
Total flying experience during last 07 Days : 24:04 hours approx
Total flying experience during last 24 Hours : 04:34 hours approx

On the date of incident the crew had reported for the first sector of the day at Mumbai airport at 0635 Z.

1.5.2 Co-Pilot:

AGE : 30 years
Licence : ATPL holder
Date of Issue : 13/03/2012
Valid up to : 12/03/2014
Category : Aeroplane
Class : Multi Engine Land
Endorsements as Co-Pilot : A-320/319/321
Date of Med. Exam. : 18/02/2013
Med. Exam valid upto : 17/02/2014
FRTO Licence Validity : Valid
Total flying experience : 2274 hours
Experience on type : 2024 hours

Total flying experience during last 180 days : 401:54 hours
Total flying experience during last 90 days : 201:14 hours
Total flying experience during last 30 days : 64:52 hours
Total flying experience during last 07 Days : 15:38 hours
Total flying experience during last 24 Hours : 04:34 hours

On the date of incident the crew had reported for the first sector of the day at Mumbai airport at 0635 Z.

1.6 Aircraft information:

Airbus A320 is a subsonic, medium-range, civil transport aircraft. The aircraft has two high bypass turbofan engines manufactured by M/S IAE. The aircraft is designed for operation with two pilots and has passenger seating capacity of 180.

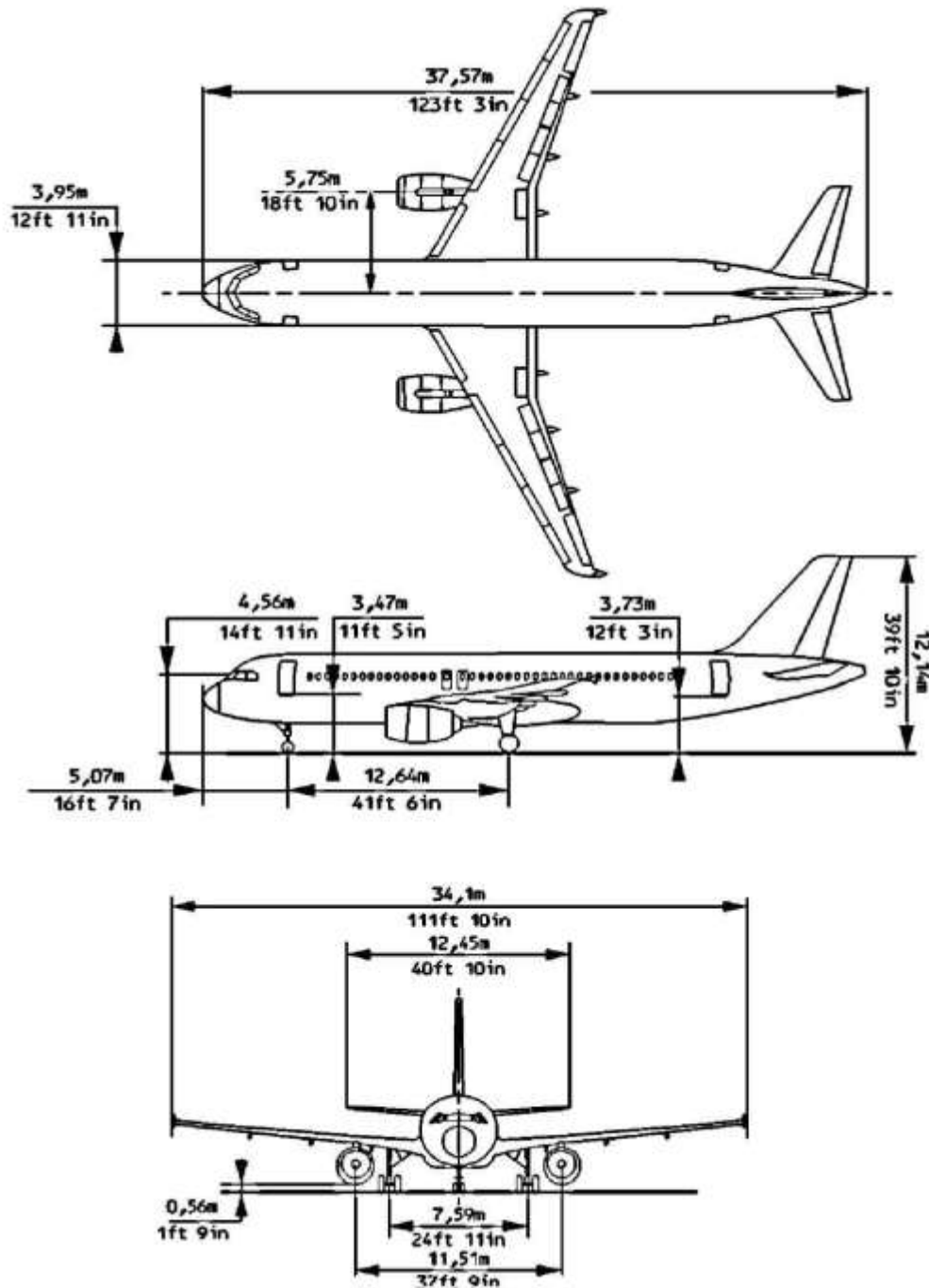

The external dimensions of the aircraft are as shown above.

The aircraft is certified in Normal (Passenger) category, for day and night operation under VFR & IFR. The maximum operating altitude is 41,000 feet (12497 m) and maximum take-off weight is 73,500Kgs. The Maximum Landing weight is 64,500 kg. The Aircraft length is 37.57 meters, wingspan is 34.1 meters and height of this aircraft is 12.14 meters. The distance between main wheel centre is 7.59 meters. The distance between engines is 11.51 meters and Engine Ground Clearance is 0.56 meters.

The Aircraft was manufactured by M/s Airbus Industries, Hamburg Germany in 25th May 2012. Aircraft is powered with V2527-A5 Engines. The Aircraft has a seating capacity for 180 persons with 02 cockpit crew and 06 cabin crew. The Aircraft has a total fuelling capacity of around 18730 kg and a total endurance of about 07 hrs.

Till the day of incident, the aircraft had done 2755:35 airframe hrs since new. The engines had also logged 2755:35 hrs since new.

The last C of A was done on 25.05.2012 and is valid till 24.05.2017. The Aircraft was registered under Normal category. The highest inspection schedule on this Aircraft is 3000 FH/ 480 days which was carried out on the Aircraft on 02.03.2013 at 2679:53/1828 FH/FC. The Aircraft was issued with Indian Certificate of Registration (C of R) no. 4329 under category 'A'. The Aircraft held valid Flight Release Certificate which was issued on 08.03.2013 and was valid till 10:30 hrs of 10.03.2013 (36 calendar hours) or upon completion of 2782:39 flying hrs by the Aircraft from the date of issuance of certificate, whichever was earlier.

After the incident, Airbus was requested to carry out load assessment on the aircraft particularly rudder and landing gear. No exceedance of load on the airframe or landing gear was observed. Specific maintenance was neither recommended nor carried out.

1.7 Meteorological information:

Time (UTC)	Visibility (Km)	Temp	DP	WINDS	QNH	QFE	Trend
1240	3.5	32	12	320/08	1009	1008	No Sig
1310	3.5	32	11	320/06	1009	1008	No Sig

No significant weather indicated in the Met report on the date of incident between 1240hrs to 1440hrs UTC. The winds varied between 06-08 knots during the above period. The runway conditions were dry.

1.8 Aids to navigation:

Aerodrome is equipped with Instrument Landing System for runway 09, 27 and 14 and DVOR is co-located with DME and VOR. Surveillance Radar approach procedures are available on 09, 27 and 14 ends of the runways with published missed approached procedures. Radar Vectoring was available. Minimum Sector Altitude for sector (340 ° - 200 °) is 2400 ft up to 12 nm and 3700 ft from 12nm to 25nm and for sector (200 ° - 340 °) is 2600 ft up to 25 nm. SID, STAR and Radar Vectoring Facilities as published were available. All the runways are equipped with PAPI lights with 3 degree glide path. Rwy 27, 14 and 32 end PAPI lighting system is available on left while for Rwy 09 PAPI lighting system is available on right.

1.9 Communications:

There was always two-way communication between the ATC and the aircraft. The crew had not reported any problem in communicating with ATC or vice-versa

1.10 Aerodrome information:

Mumbai International Airport Limited is operated by M/s GVK. Airport has two cross runway 09/27 and 14/32 with ARP location 190530 N 0725158 E and

elevation of 37 feet from mean sea level. Rwy 27 is 3190 m, Rwy 09 is 3050 m, Rwy 14 is 2774m and Rwy 32 is 2823 m in lengths.

Airport is equipped with ATS communication facilities .Mumbai is Class 'D' airspace with vertical limits from surface to FL 70 and lateral limits of 40 nm from DVOR, VFR/IFR operations and traffic separation are permitted. Aerodrome is equipped with facilities like fueling, Cargo-handling, Hangar space and Repair facilities for visiting aircraft. Aerodrome is equipped with Category 10 type of fire fighting facilities. Pushback facility is available. SID, STAR and Radar Vectoring Facilities as published are available. All the runways are equipped with PAPI lights with 3 degree glide path. Meteorological Information can be availed for 24 hours.

1.11 Flight recorders:

The aircraft was fitted with SSCVR and SSFDR. After the incident both were replaced and replayed in the CVR/FDR laboratory of the AED, DGCA, Delhi. Correlation of the DFDR and CVR transcript (audio) was carried out which was superimposed on the aerodrome topography. Copy of the CVR recording, DFDR data and other evidences were provided to BEA France and report based on the analysis of CVR and DFDR recordings etc. was received from BEA France. Various DFDR parameters/ indications were as follows:

a) Initial condition

The approach was stabilized. Main information is the following:

- Gross Weight : 58.9t
- CG : 32.6%
- Configuration : Full
- CAS : $\approx 135\text{kt}$ (VLS=128kt)
- Auto-Brake armed in LOW
- FDs were engaged in LAND Track
- Auto Throttle was engaged in SPEED mode
- The Captain was the Pilot-Flying

b) At touch-down

- Max Vertical g : +1.16g

- Lateral g : - 0.03 g
- Roll : 1.76⁰ (RH wing down)
- CAS : 129 kt
- Spoilers extended and reverse deployed
- Left rudder pedal input leading to a left rudder deflection up to 10⁰
 - ✓ LOC deviation started to increase (aircraft on the left of the runway)
- Captain side-stick input upto 10⁰ rightward

c) Between 13.05.06 and 13.05.19 UTC – left rudder inputs

- Several rudder pedal inputs leading to a left rudder deflection up to 23⁰
 - ✓ Lateral g varied between -0.22 g and +0.19 g
 - ✓ LOC deviation was still increasing upto 25 A (aircraft on the left of runway)
 - ✓ Heading increase from 267⁰ to 273⁰
- Captain rightward side-stick inputs up to 15⁰
- Auto brake was disconnected through a brake pedal input
- CAS was decreasing

**d) Between 13.05.20 and 13.05.55 UTC
(Opposite rudder inputs and lateral runway excursion)**

- Several opposite rudder pedal inputs leading to a rudder deflection up to max left and right
 - ✓ Lateral g varied between -0.35 g and +0.2 g
 - ✓ LOC deviation increased upto a max of 123 A (aircraft on the left of runway)
 - ✓ From touchdown to end of landing roll, heading changes are between 261⁰ to 282⁰
- Captain rightward side-stick inputs up to the max deflection (20⁰)
- Several brake pedal inputs on both pedals
- CAS was still decreasing

The findings of the BEA report and deductions arrived at has been used in the Analysis part.

1.12 Wreckage and impact information.

The Aircraft touchdown was in the touchdown zone slightly left of the runway centre line. No significant or abnormal marking of tyres was seen in touch-down zone. Thereafter ground marks indicate that the aircraft started veering further to the left at approximately 1600 meters from the threshold. The left deviation increased and the left main wheels reached the left shoulder up to a maximum deviation of 31.5 meter from the runway centreline. At this point two sequential runway edge lights were damaged.

The left main wheel after travelling for approx. 200 meters near the runway edge lights exited the paved surface and entered the soft ground on the left side breaking five runway edge lights in the process. The aircraft then was steered back on the runway and taxied to bay under its own power. During inspection, glass pieces were found on the main wheel and deep cuts found on the tyre. There were signs of mud on the sidewall indicating that the wheel had entered 'kutchha' after leaving the paved surface on the runway.



Tyre marks on the kutchha and runway

1.13 Medical and pathological Information:

Both the Captain & First Officer had undergone preflight medical check prior to the flight and was found satisfactory. After the incident the breath analyzer test was carried out and same was found to be negative.

1.14 Fire

There was no fire after the incident.

1.15 Survival aspects:

The incident was survivable.

1.16 Tests and research:

Nil

1.17 Organizational and management information:

The aircraft is owned by a scheduled airline which has a fleet of 65 Airbus A-320 aircraft (on the date of incident). It operates flights on domestic and international sectors. The Company is headed by CEO assisted by a team of professionals heading each department. The flight operation is headed by V.P. Flight Ops who holds current license on Airbus A-320. The Flight Safety Department is headed by the Chief of Flight Safety who is a pilot with a current license of Airbus A-320. He reports directly to CEO. The operator has a training center, where all ground training is conducted by DGCA approved ground instructors. It also utilizes the CAE Simulator facilities at Bengaluru, Dubai, Madrid and FSTC at Gurgoan.

The Chief Pilot (Standards and QA) functions under the authority of the Director (Flight Operations). He is responsible for Flight Crew Standards and Quality Assurance of Flight Crew Training. He is accountable to the Vice President (Flight Operations) for Compliance on all Training Standards. His main functions are audit of flight operation training and line operations standards. His responsibility also includes Flight Data Monitoring (FDM) and

Standardization of Flight Crew and procedures followed by in-house pilot counseling. He is thereby responsible for ensuring acceptance and overview of any residual risk or hazard, and their associated control in accordance with the procedures. He has also to ensure that all executives and staff reporting to him are trained, qualified and competent to discharge their safety related obligations. He has also to see that if there are any safety issues, the same are identified and reported in a timely manner so that mitigation process can be initiated at the earliest.

As the incident was purely of operational nature, the committee reviewed the company “Operations Manual” particularly to understand the flight crew induction, training (initial and refresher) and flight operations aspects of the operator. Organisation structure is laid down in Para 1.1 and Flight Operations departmental structure is laid down in Para 1.1.1. The organisation structure was studied in detail to look for latent failures vis-a-vis DGCA CAR on “safety regulation and oversight of flight operations”. The details of which have been mentioned in ‘Analysis’ of this report.

The incident was not reported immediately to the concerned authorities as required by the CAR on the subject. The change of wheel was initiated and the aircraft log book revealed that the crew had initially entered ‘NIL’ in the snag/observation column.

ORGANISATION STRUCTURE:

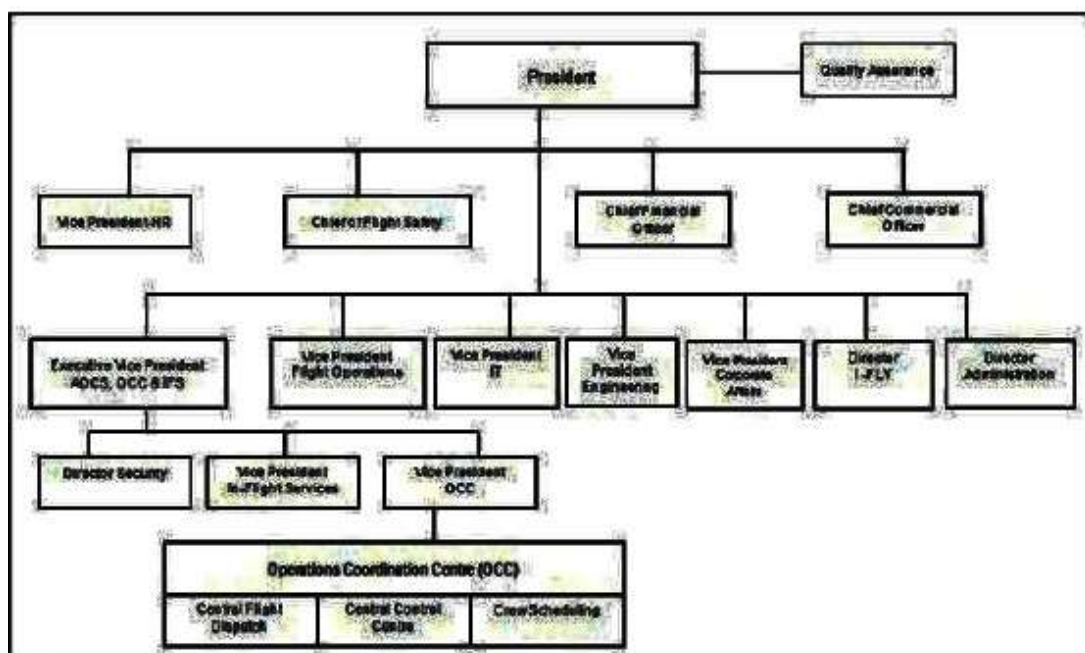

1.18 Additional information:

Nil

1.19 Useful or effective investigation techniques:

Nil

2. ANALYSIS

2.1 Serviceability of the aircraft:

The aircraft was fully serviceable with Valid C of A and Flight Release Certificate. No defect was reported prior to the Subject Flight and there was no deferred maintenance in the Tech. Log. No defect was reported during the Flight. The post Flight report also did not indicate any defect during the flight. An assessment was done to determine the loads experienced at the Rudder as a result of extreme rudder pedal input and the loads experienced on the landing gears further to the runway excursion. No exceedance on the airframe or landing gear was observed as per the report received from Airbus and hence no specific maintenance task was required to be carried out. As such maintenance task post incident as per the Aircraft Maintenance Manual were carried out. Serviceability of the aircraft has not contributed to the incident.

2.2 SSFDR/ CVR readouts and correlation:

2.2.1 SSFDR

The report on the incident based on DFDR data was received from BEA France (portion given in para 1.11). It was observed that at 18:32:52 (1500 Feet RA); 18:33:35 (1000 Feet RA); 18:34:10 (500 Feet RA) - the aircraft was fully configured and on profile with speed/ ROD within limits. At 374 Feet RA the approach was stable with all parameters within limits, auto pilot was disconnected and manual control taken over by PIC. At time 18:34:54 (36 Feet RA) flare was initiated by PIC. At the same time shift in wind was observed from 330/ 10-12 Kts to 297/5 Kts. This lead to slight deviation from the path for which correction was given by PIC.

At 18:35:03 the right main landing gear touched down first and at a second later, left main landing gear touched. The touchdown was left of center line. Two seconds after right main landing gear touchdown Max reverse were deployed. Also simultaneously rudder deflection is recorded. During landing roll rudder position was observed to be changing (plus 25 to minus 25 Deg).

The parameters between time 18.35.20 and 18.35.55 indicates that several opposite rudder pedal inputs leading to a rudder deflection up to max left and right. The relevant parameters are reproduced below:

- ✓ Lateral g varied between -0.35 g and +0.2 g
- ✓ LOC deviation increased upto a max of 123 A (aircraft on the left of runway)
- ✓ From touchdown to end of landing roll, heading changes are between 261⁰ to 282⁰

In addition Captain had given rightward side-stick inputs up to the max deflection (20⁰). There were several brake pedal inputs on both pedals with CAS decreasing.

The graphical representation of rudder pedal, lateral side stick inputs, rudder deflection v/s lateral 'g' and rudder deflection v/s localizer deviation are shown below.

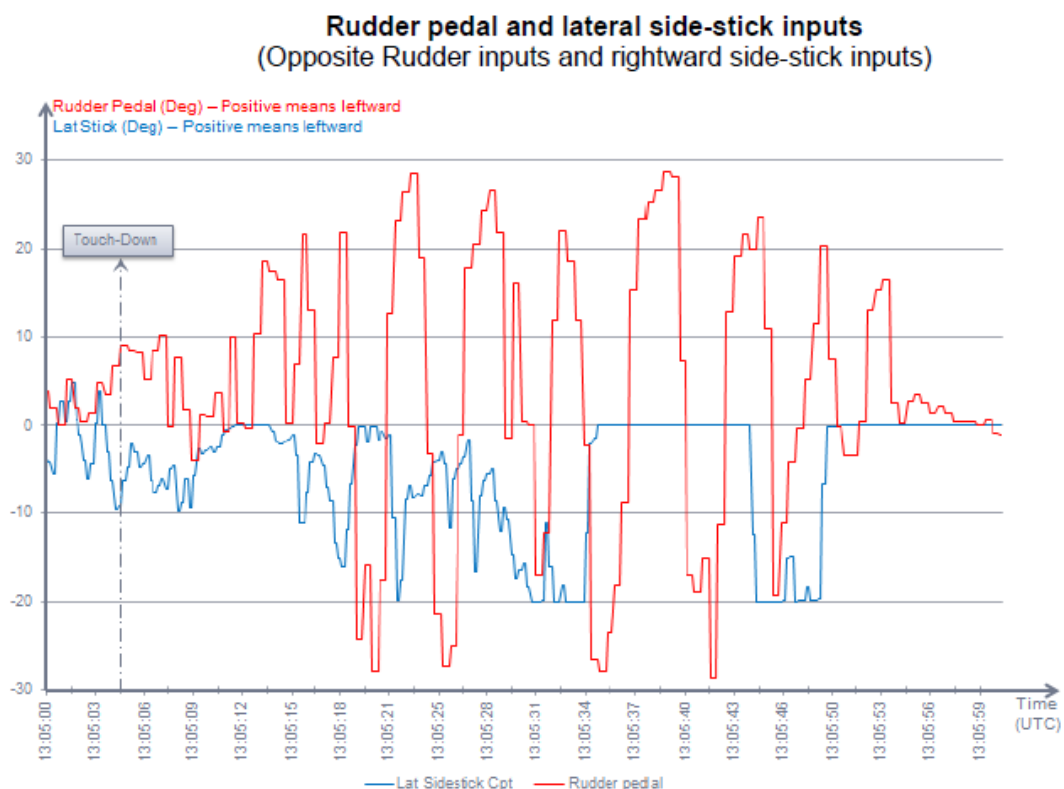

Rudder deflection versus Lateral g
 (Rudder deflections up to max left and right – Lateral g variation between -0.35g and +0.23g)

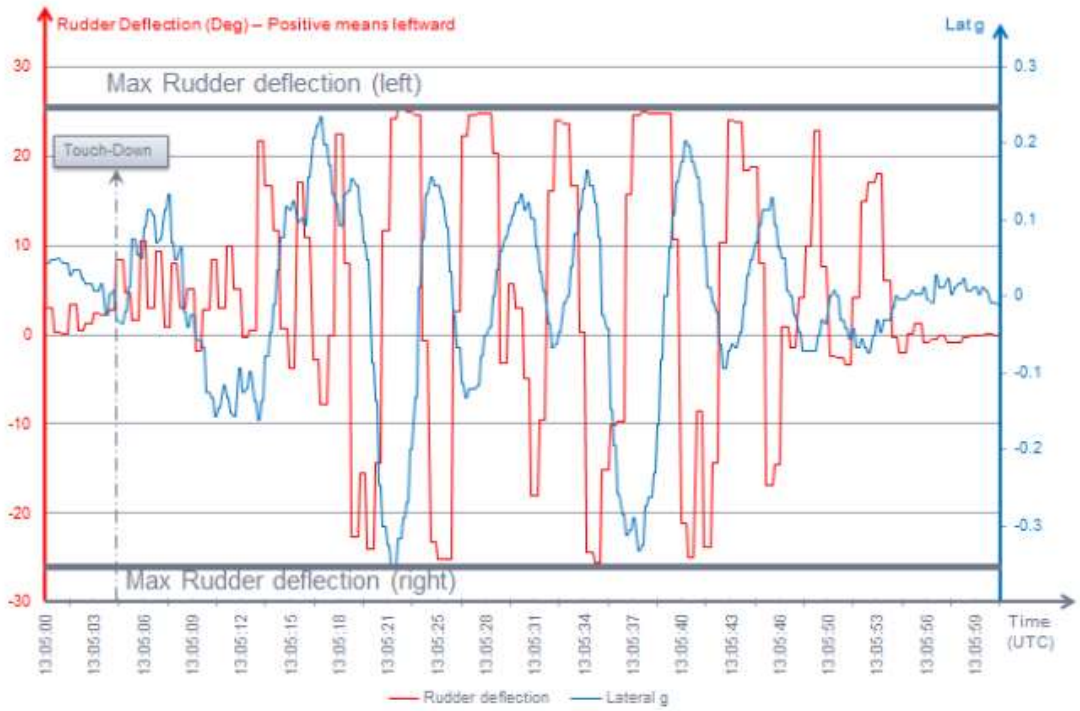

Rudder deflection versus LOC deviation
 (A/C on the left of the LOC beam)



2.2.2 SSCVR:

The CVR was downloaded and replayed. CVR indicates that the flight was proceeding normally with all callouts and procedures till 1000 ft. Retard Call is recorded at 18:34:58. The flight was uneventful and stabilized at 1000 ft. Six seconds later call for Ground Spoilers is recorded. At 18:35:10 First Officer calls out center line. P1 responds check correcting. Thereafter the Captain mentioned that winds were from the right and to check the crosswind. The First Officer cautions the captain about the center line seven seconds after the touchdown. Thereafter Captain asked what happened. Sixteen seconds after touchdown First Officer again called to Captain that he is going off and captain responded that he has control. Captain again reiterated that he got control. Thirty three seconds later First Officer said "should I take over" to which captain responds by saying "I got control".

The above indicated that seven seconds after touchdown First Officer realized that the aircraft was veering to the left from the centre line and gave appropriate call out to which Captain responded. Thereafter there was a discussion as to what happened. Four seconds later First Officer again called Captain by name saying that you are going off and again the Captain responded by saying that I got controls.

Once again the Copilot asked whether he should take over control however captain again said I got controls. During taxi, there was a discussion about whether there was a cross wind but First Officer said not much. Ground Control asked the reason for not following the center line to which Crew responded that they thought there was cross wind.

2.3 Weather:

Weather at the time of occurrence was fine. There was not much of cross winds reported. Although the flight crew has reported that they experienced cross winds upto 20 kts at 500 feet above ground level, but the reported surface winds were 8 kts at 340 degrees. The relevant METAR is as follows:

Time (UTC)	Visibility (Km)	Temp	Wind	DP	QNH	QFE	Trend
1240	3.5	32	320/08	12	1009	1008	No Sig
1310	3.5	32	320/06	11	1009	1008	No Sig

The DFDR data also indicates that the winds were 330/10-12 kts and changing to 297/05 kts. Weather has not contributed to the incident.

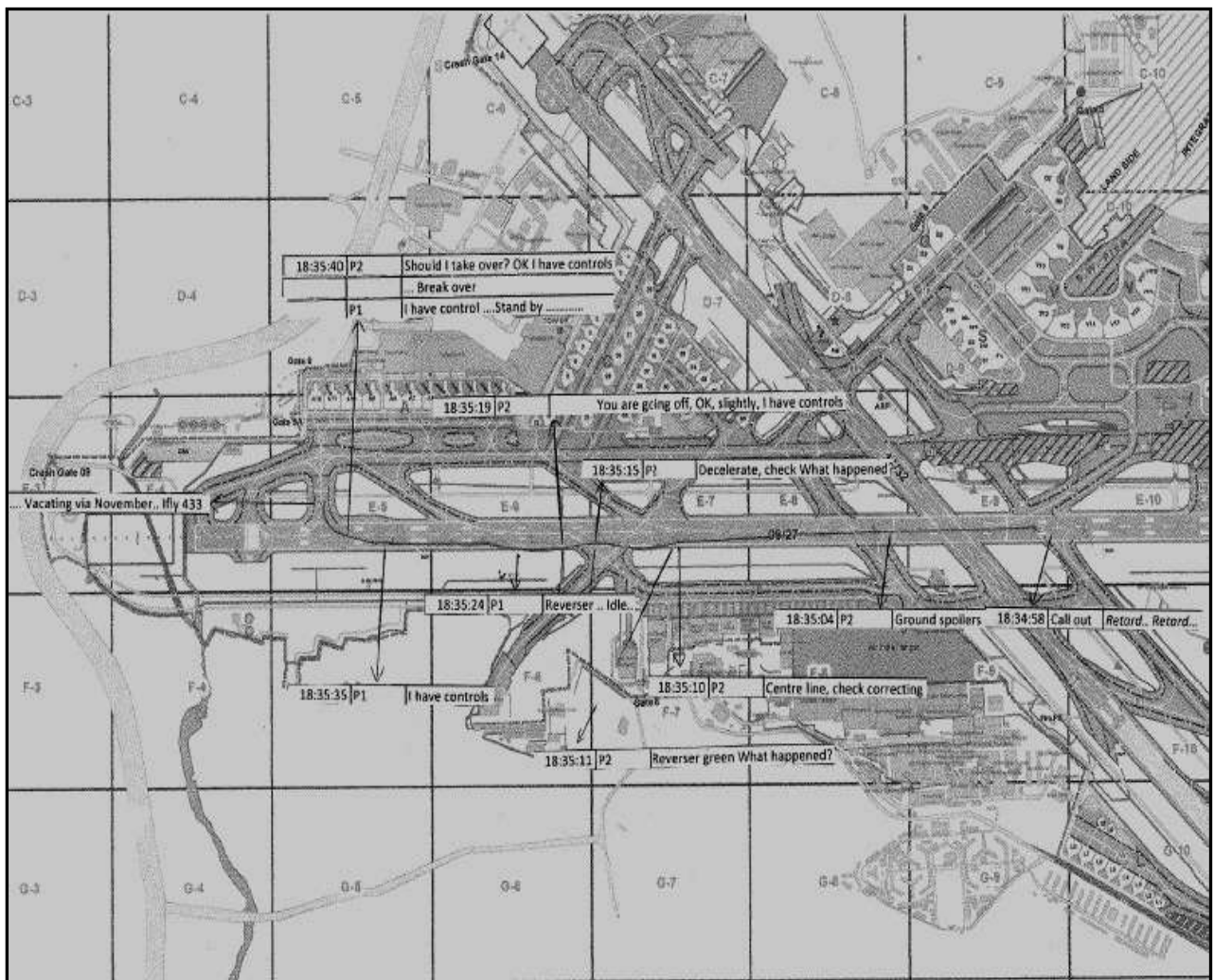

CVR readout superimposed on Airport map

2.4 Pilot handling of the aircraft:

The DFDR readout showed that immediately after touch-down, left rudder pedal inputs led the aircraft to deviate to the left (aircraft on the left of the LOC beam). During the next 30 seconds, pilot applied several rudder pedal inputs

up to the max left and right sides. The LOC deviation increased to reach a maximum of 123 (aircraft on the left of the runway). During that time several brake pedal inputs were also applied on both sides. The justification of the pilot that there were heavy cross winds could not be corroborated with other evidences. The Captain though was on controls but was unaware of the actions he was taking. He has deviated from the centerline and reached the extreme left which might have been due to loss of situational awareness.

2.5 CRM

The CVR/DFDR analysis shows that the flight crew followed company procedures till the point of incident and the aircraft was stable during the approach. Even after touchdown the First Officer (Pilot Monitoring) continued giving the “Standard Callouts” and the deviation calls. No inputs on the controls were observed on the DFDR from the First Officer (Pilot Monitoring) side. No “Dual Input” audio call was recorded on the CVR.

The first officer was aware of the aircraft heading towards the left edge and the Captain, though acknowledging his calls, was not responding with appropriate inputs. He could have played a more pro active role by taking controls to preclude the impending runway excursion.

2.6 Discussions on possible scenarios

All the possibilities which could have resulted into the incident were explored and are detailed as below:

a. Rudder Jam:

As per the QRH (Ref Abnormal & Emergency procedures 27.04 A), “Rudder Jam is detected by Undue (and adverse) pedal movement during rolling maneuvers. This is because the “Yaw Damper“ orders can no longer be sent to the rudder by the pilot nor are fed back to the pedals.” The handbook advises to carry out visual check of rudder position” as per the given procedure. Post incident discussion with the flight crew indicated that no rudder jam was suspected by the flight

crew nor was it observed after post flight inspection by the engineering staff. DFDR data also indicated that rudder movement was consistent with the rudder pedal inputs. This rules out Rudder Jam as a cause of the incident.

b. Rudder Pedal Stiff:

- a. As per the QRH (Ref Abnormal & Emergency procedures 27.03 A), “Even if the Auto-Pilot is disengaged the rudder pedal may be stiff. This may affect either:
 - i. Both side stick (Capt & F/o) at the same time but not the Rudder pedals, or,
 - ii. One side stick and rudder pedals
- b. In such a case, the piloting technique remains the same; the aircraft remains responsive. However the flight crew should keep in mind that they may need to use extra force on the side stick and/or the rudder pedals”. Post incident discussion with the flight crew indicated that no rudder stiffness was experienced by the flight crew.

c. Nose Wheel Steering fault:

No Nose Wheel Steering fault was recorded in flight and no work was done on the Nose Wheel Steering system post the incident.

d. Skidding due to rubber deposits:

- a. No visible marks of skidding was observed post incident on the runway nor was it reported by the flight crew.
- b. Runway conditions were dry.

e. Thrust Reverser asymmetry:

DFDR data revealed that there was no thrust reverser asymmetry and nor was any strong cross wind experienced during the landing roll to cause any yawing movement/ deviation.

2.7 Organisation

2.7.1 Flight operations & training of cockpit crew

In view of the serious nature of incident and non existence of the above mentioned possibilities, exhaustive review of the documents and existing procedures in the department of Flight Operations with particular emphasis to the training of cockpit crew was carried out. This was carried out totally with a view to have a deeper insight into the latent hazards, if any, and to recommend precautionary actions.

Although at the first look at the “Organisation” structure seemed normal and well defined, but on deeper analysis, it was observed that only Check-Pilots’ & Instructors’ were reporting to the Chief Pilot (training). Though Chief Pilot (Training) is responsible for training of flight crew, including training of the training Captains, but the examiners in the Airline report to “Chief Pilot {Standards & Quality Assurance) and not to Chief Pilot (Training).

Due to rapid expansion, the airline had recruited flight crew in mass scale in the year 2012. During the interview of the then Director (Flight Operations), the process was discussed and it was agreed that the procedure was falling short in quality assessment. In that process “Type Rated” flight crew were straightway interviewed and recruited in the airline, which (quality) could have been improved by introducing few quality and professional (psychometric etc.) checks. It is not to emphasise that careful recruitment is one of the best investments for an airline to enhance safety.

While reviewing the Operations Manual (OM-A Para 1.3.6), it was observed that Standardization of Training Captains (Check-Pilots, Instructors & Examiners) was carried out by Chief Pilot Standards & Quality Assurance. He also monitors and nominates personnel to carry out all evaluations and checks on the simulator and for line release, command assessment, evaluation and special assessment/ evaluations required by the company; carries out Flight Data Monitoring, analysis of the Flight Data and the Flight

Crew counseling. This not only creates conflict but is also not in line with DGCA CAR on the subject.

With reference to OM-A Para 1.3.6, Company Flt Ops structure indicates that Chief Pilot (Standards & Quality Assurance) reports to Director (Flt Ops) but the OM-A Para 1.3.6 mentions that he reports to VP (Flt Ops). He is responsible for auditing the Flt Ops Training and Line Ops Standard but no evidence was made available during the visit of the Committee to the company. During discussions, it also came to light that the airline currently does not conduct any CRM for flight crew who are type rated and join with experience. This leads to a situation of every experienced flight member employed with the airline to have a different understanding of the principles of CRM. A standardised company CRM as per DGCA CAR on the subject is not carried out.

2.7.2 Role of Flight Safety Department

As per the various CARs of DGCA under Section 5, the operators are required to have a Flight Safety Department with proper and appropriate manpower. This department in principle is Regulator's (DGCA) extension in the organisation. The duties, responsibilities and authority of this department have been mentioned in detail in the CARs and circulars issued and amended by DGCA from time to time. The airline must take due cognizance of these requirements in true spirit so that a meaningful purpose is served by the Flight Safety Department.

- a. **Operational Safety Risk Assessment (OSRA):** While reviewing the OSRA reports of the airline, it was observed that "Risk Matrix" followed by Flt Ops was different in a few cases. This was not in-line with company OM-A (Chapter 34) and the company SMS manual.
- b. **Flight Operations Quality Assurance (FOQA):** Currently the airline follows a concept of data downloading and categorization by the Flight Safety

department. Thereafter the categorised data is shared with Chief Pilot (Standards & Quality Assurance), who in turn decides on the future course of action on the data. Chief Pilot (Standards & Quality Assurance) solely decides on the action to be taken, which may not at times result into proper redressing of the causes. At times it has lead to a situation that only selective “Red” events were addressed. Principally all “RED” events need to be addressed by counseling of some form but definitely not closed by an email. The delay in flight crew counseling was observed to be around 2-3 months in some cases.

- c. **FOQA Trends report:** Quarterly FOQA Trend report is published with a delay of more than 4-6 months, rendering the exercise futile.

FOQA and incident data was not being used to enhance training. Currently no process exists to identify individual pilot strength & weakness, nor is the general FOQA trend used for training purpose. Simulator training profile was reviewed and was observed as not standardised (exercises and environment). It was left to the individual instructors to conduct training.

2.8 Circumstances leading to the Incident

A. Loss of Situational Awareness

The aircraft had touched-down with a slight crab to the left of runway centerline. There was left rudder input due which the aircraft started drifting further left of centerline. The Captain has mentioned that he looked inside to ensure that both thrust reversers were deployed correctly. Thereafter when he shifted focus to external visual segment he perhaps got disoriented and mistook the left runway edge lights as the center line. Thenceforth, having lost situational awareness, he continued to maintain the left runway edge in spite of few callouts by the First Officer.

B. Improper Rudder Technique

Immediately after touch-down, left rudder pedal inputs led the aircraft to deviate to the left (aircraft on the left of the LOC beam). During the next 30s the pilot applied several rudder pedal inputs up to the max left and

right sides. The LOC deviation increased to reach a maximum of 123mA (A/C on the left of the runway). During that time several brake pedal inputs were also applied on both sides. Improper use of the rudder by the Captain contributed to the incident.

C. CRM – unassertiveness of the First Officer

The First Officer though aware of the situation that the aircraft is about to exit the runway from the left edge and that the Captain was not taking appropriate corrective action could not assert himself to take over controls.

3 CONCLUSIONS:

3.1 Findings:

1. The aircraft was having a valid Certificate of Registration and Certificate of Airworthiness. The ARC was also valid.
2. All the maintenance schedules, mandatory modifications and checks were carried out as per the requirements. There were no defects / snags pending rectification.
3. The aircraft weight and CG were within limits.
4. The aircraft was on a scheduled flight (Chandigarh – Mumbai) under the command of an appropriately licensed ATPL holder with another ATPL holder as FO.
5. The medical of both the cockpit crew members was valid. Both have undergone pre-flight medical checks including BA test which was negative.
6. No abnormalities were observed on the flight from Chandigarh, enroute and till touch-down at Mumbai. The approach was stabilized with CAS of about 135 kts. Auto-pilot was 'ON' till 400 AGL.
7. After touch-down the aircraft deviated towards the left. The Captain diverted his focus from external visual segment to aircraft instruments. Thereafter, on shifting his focus back to external visual cues, he got disoriented and mistook the left runway edge lights as the center line.

Thenceforth, having lost situational awareness, continued to maintain the left runway edge in spite of callouts from the First Officer.

8. The First Officer was aware of the situation and could have played a proactive role by taking over controls thus preventing runway excursion, as he had realized that the Captain was not taking appropriate remedial action.
9. During landing roll several successive rudder pedal inputs were applied on both sides.
10. The incident was initially not reported and rectification work of replacement of wheels was initiated.
11. Though, the OSRA, FOQA and SMS implementation etc. in the airlines were being carried out, yet due to non availability of checks & balances, desired effects of these safety features were missing.
12. In few cases, the risk matrix being used by the Operations department for evaluation of the risk and its mitigation was different than the SMS Manual of the airline.
13. Organisational isolation between the Flight Crew Training/Operations Department and Flight Safety Department was evident.

3.2 Probable cause of the Incident:

The Captain got disoriented about the aircraft position with respect to runway centre line, which resulted in loss of situational awareness.

Improper use of the rudder inputs by the Captain to achieve the desired aircraft trajectory contributed to the incident.

4 SAFETY RECOMMENDATIONS:

1. The airline :

- **On initial induction and training**
 - must include technical examination, psychometric testing, and simulator assessment in the initial assessment process of all types of flight crew.
 - must ensure that examiners responsible for training(s) imparted to the flight crew including Training Captains & Examiners report to Chief Pilot (Training).
 - As far as possible, Chief of flight crew training should function independent of the Operations Department.
 - ensure that all operating departments implement “Internal Quality Audits” for continuous improvement of the functioning departments.
 - for clear understanding of flight crew, must implement Crew Resource Management (CRM) concepts across the airline as defined in DGCA CAR.

- **On Flight Operations Quality Assurance (FOQA)**
 - Trends report must be published by the Flight Safety Department.
 - Only de-identified trends from the FOQA program (and incident data) be used to enhance pilot training.
 - A separate list of repetitive events (including snags/occurrences) or involvement of individuals should be maintained by Flight Safety Department and shared with Flt Ops for taking immediate corrective action.

- **On Flight Safety Department**
 - must have additional active pilots, responsible to the Chief of Flight Safety on all aspects. They should work as “Gate Keepers” of the FDM data, be actively involved in carrying out Flight Data analysis (FDA), Surveillance flights, flight crew counselling, carrying out OSRA, Ramp inspections, Cabin inspections, Airport Safety Risk assessment and addressing deficiencies observed during routine monitoring of CVR’s & SOP compliance.
 - in order to have better transparency, Flight crew counselling be carried out in the Flight Safety department with Fleet Captain (Safety) as a witness to the process.

- **For Safety Management System (SMS)**
 - All senior management personnel must be made conversant with the process of “Risk Assessment”. Each departmental head must ensure “Risk Assessment” be carried out in their areas of work
 - Each department must maintain their Hazard log and continuously monitor the existing defences by using standardised risk matrix against the known hazards in-line with the Company SMS manual.
 - A central Hazard log must be maintained at the flight safety department to ensure oversight.
 - Operational Safety Risk Assessment (OSRA) needs to be a realistic exercise and in line with the laid down DGCA norms for safe flight operations, with a representative from the Flight Safety department. Final approval should be on behalf of the “Accountable Manager”.

- In case of any occurrences, the **Engineering department (Shift-in-Charge) & Director Engineering** should (as per the CAR on the subject)
 - immediately report the matter to the local DGCA office
 - immediately report the matter to the Chief of Flight Safety, and
 - inform the DGCA office regarding the maintenance/ rectification work done after the occurrence and to make the aircraft serviceable. .

2. DGCA may carry out **regulatory audit of the airline** covering the above points and with particular emphasis to ensure
- Compliance with laid down DGCA CAR's, AIC's & Circulars.
 - That all departments are carrying out "Internal Audits" to ensure continuous improvement.
 - That the Flight Safety department has been made responsible for FOQA, Pilot counseling, Surveillance flights etc. as per the DGCA CAR(s) on the subject in order to have the desired preventive results.
3. DGCA may ensure that the recommendations given at point 1 above are also implemented by other scheduled airlines.

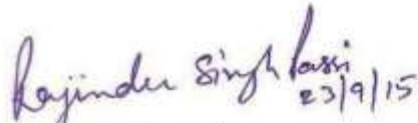
(R.S. Passi)

Chairman Committee of Inquiry

(Capt. Rajiv Yadav)

Member Committee of Inquiry

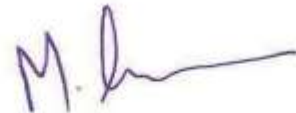

(Sh. Manoj Kumar)

Member Committee of Inquiry

DATE 23.9.2015
PLACE DELHI